

Navitect II

Detail:

- N1 Dakgoot aansluiting
- N2 Nok aansluiting
- N3 Verticale overgang Navitect II naar pannen
- N4 Verticale overgang pannen naar Navitect II
- N5 Horizontale overgang pannen naar Navitect II
- N6 Oplossingen woningscheidende wand
- N7 Dakraam boven- en onderaansluiting
- N8 Dakraam zijaansluiting
- N9 Verticale aansluiting Navitect II

-  Isolatie
-  Baksteen of dakpan
-  Beton / kalkzandsteen
-  Doorgesneden hout
-  Zijaanzicht hout
-  Spaanplaat
-  Navitect systeem
-  Navitect PV-panelen

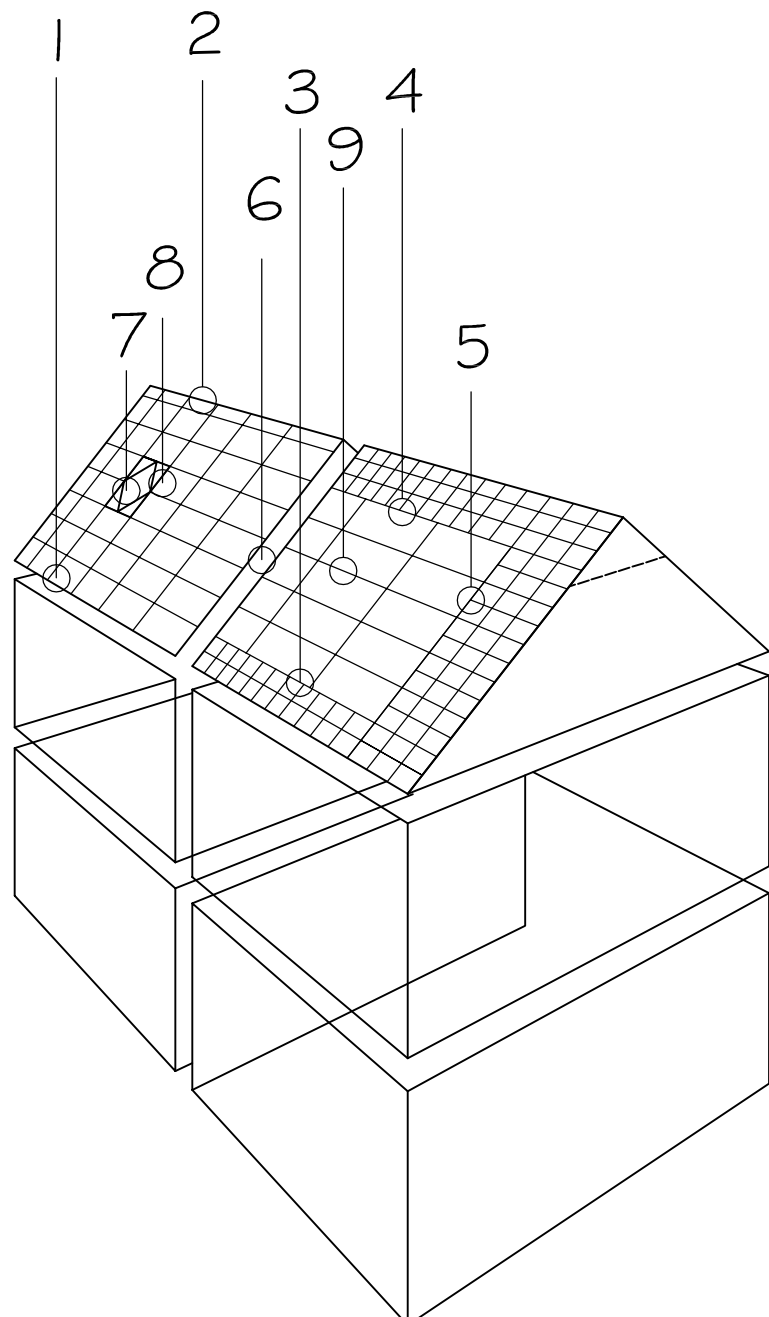

N1a Dakgoot aansluiting

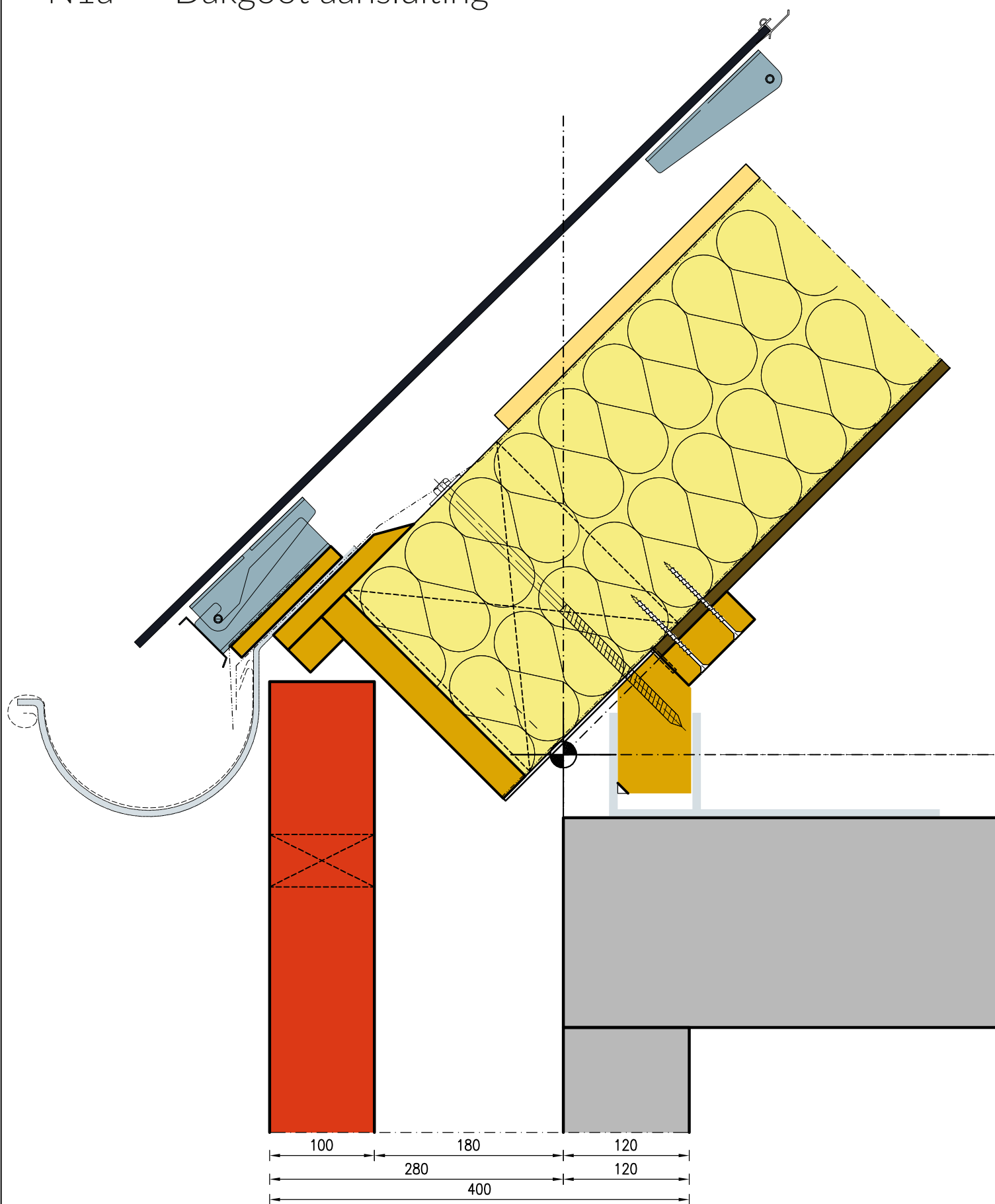

N1c Dakgoot aansluiting

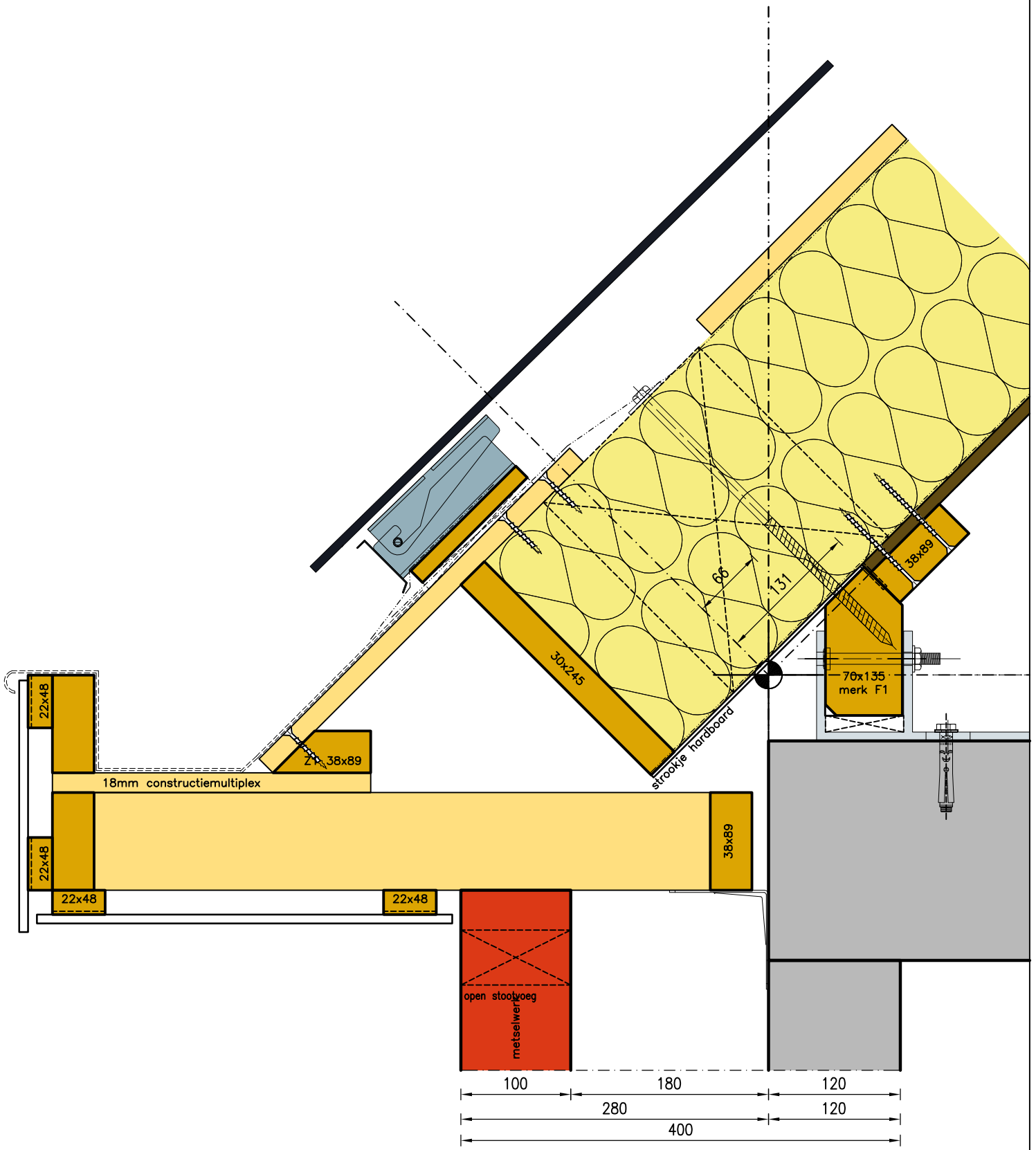

N2

Nok aansluiting

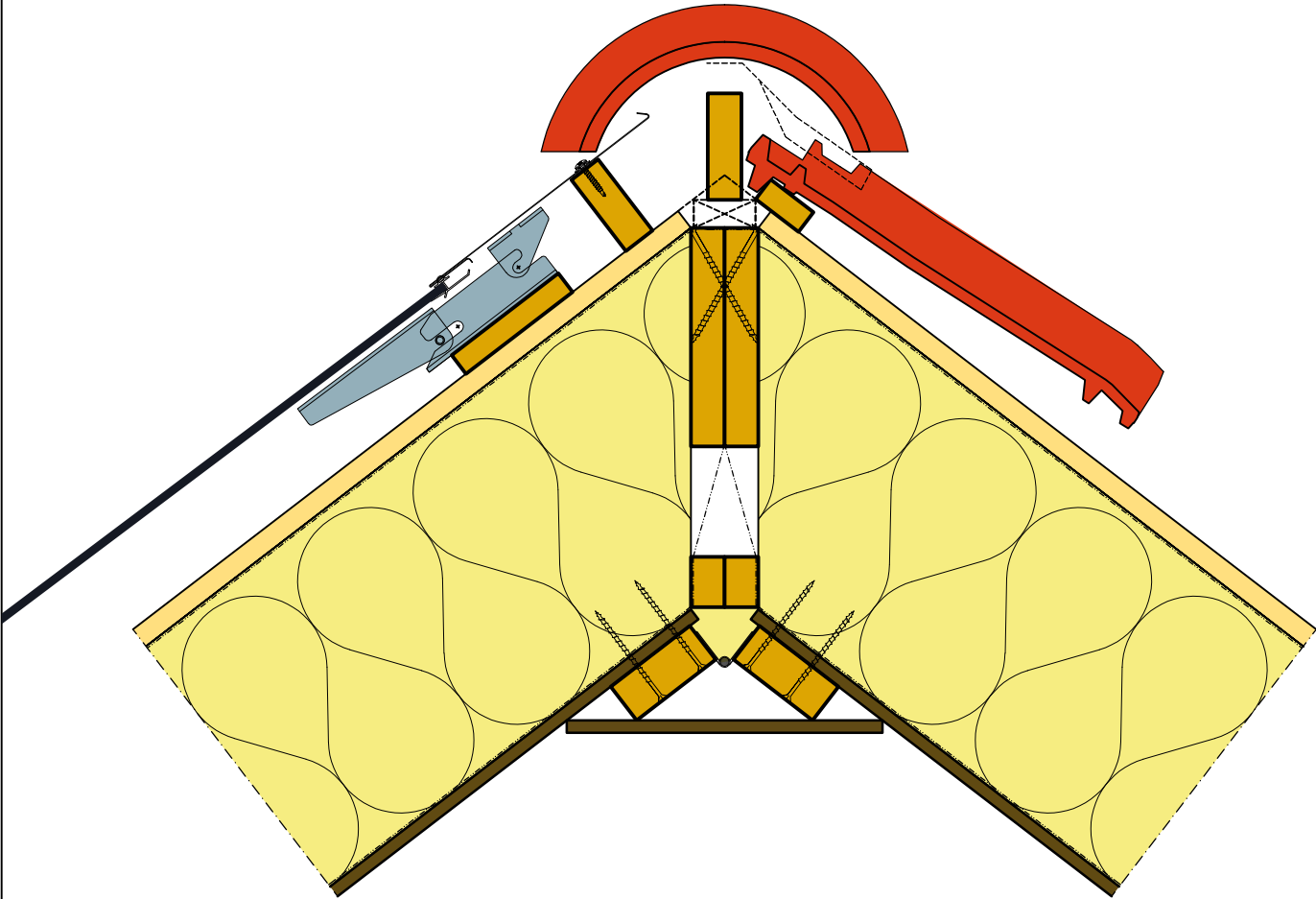

N3

Verticale overgang Navitect II naar pannen

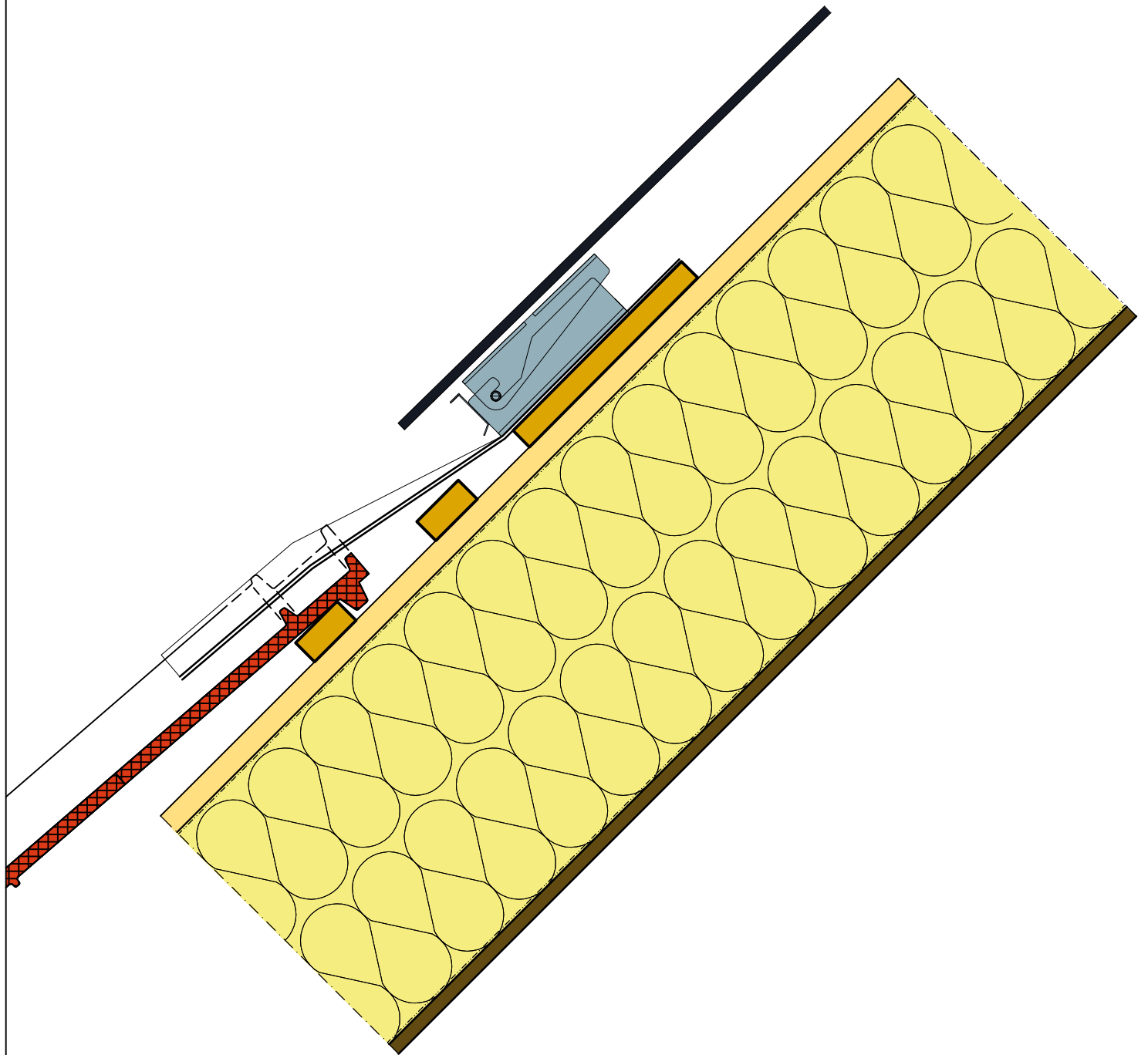

N4

Verticale overgang pannen naar Navitect II

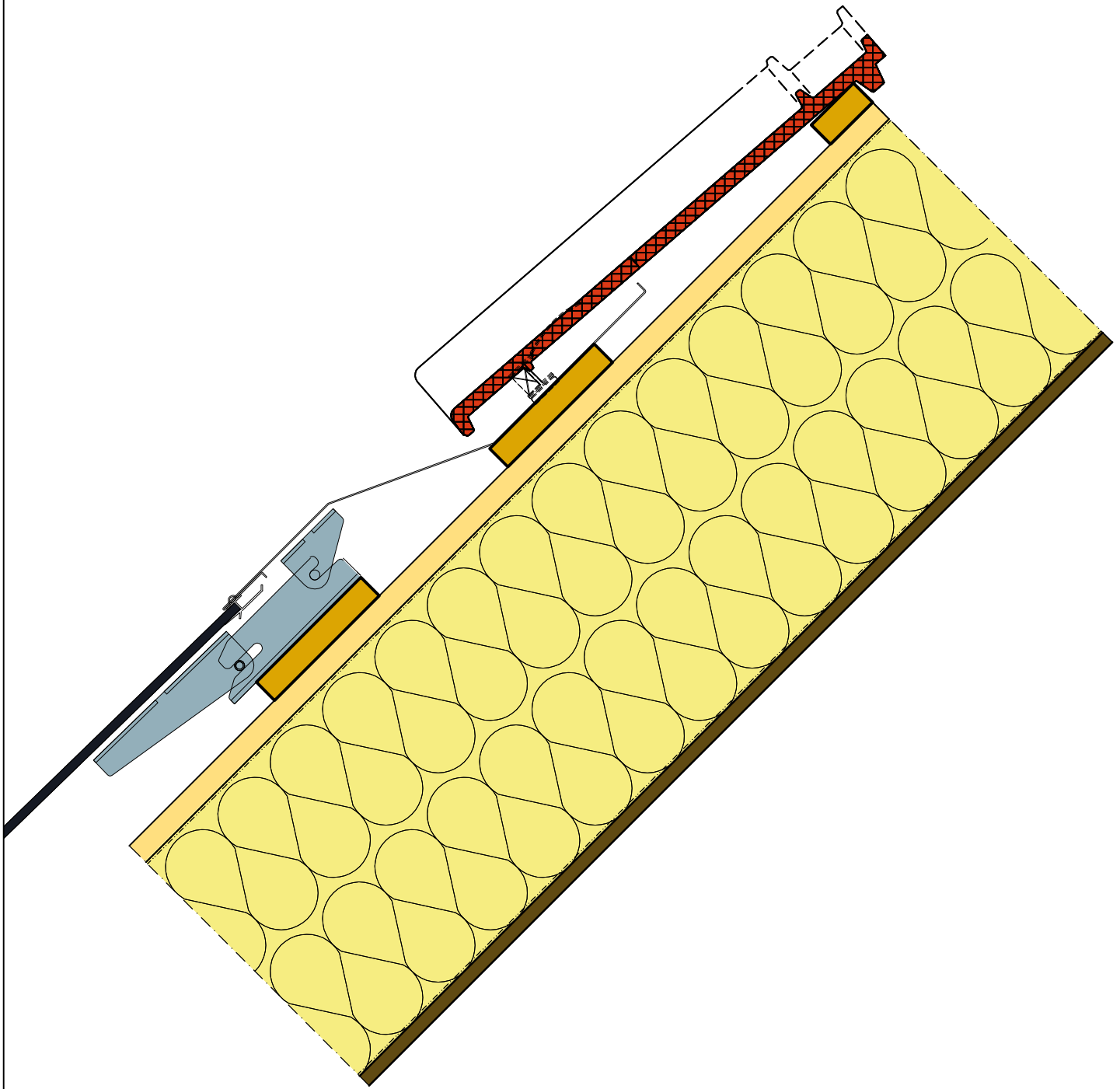

N5

Horizontale overgang pannen naar Navitect II

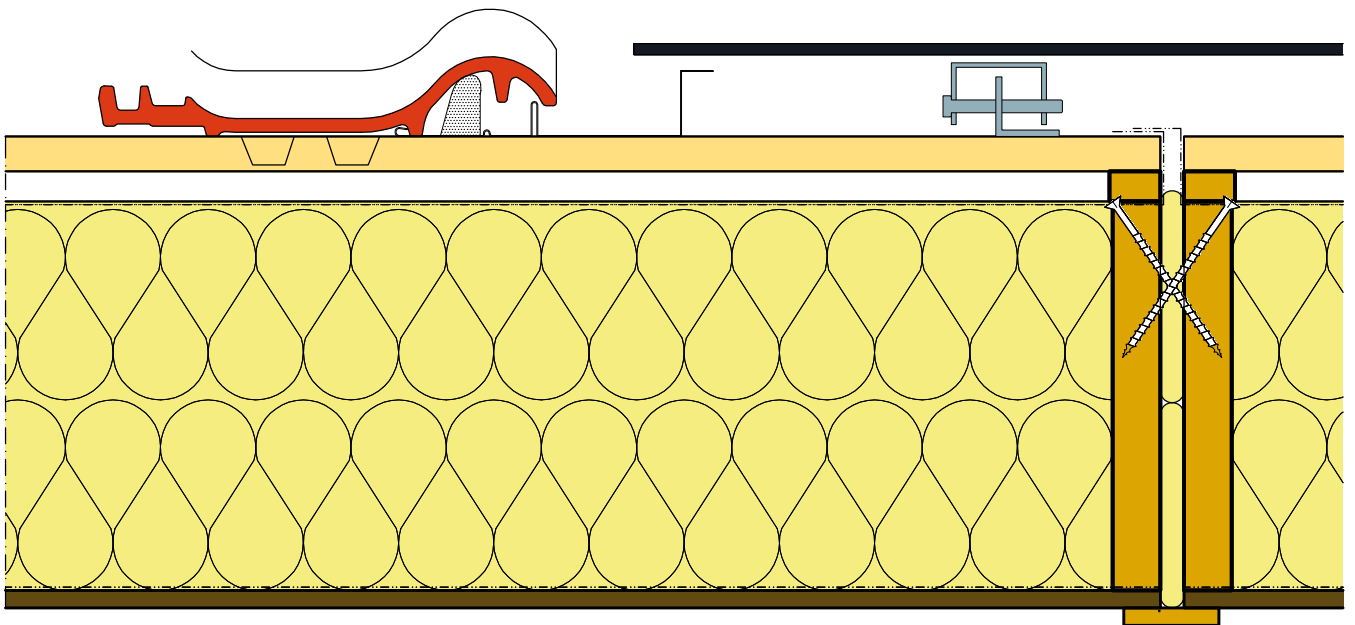

N6

Oplossingen wongingscheidende wand

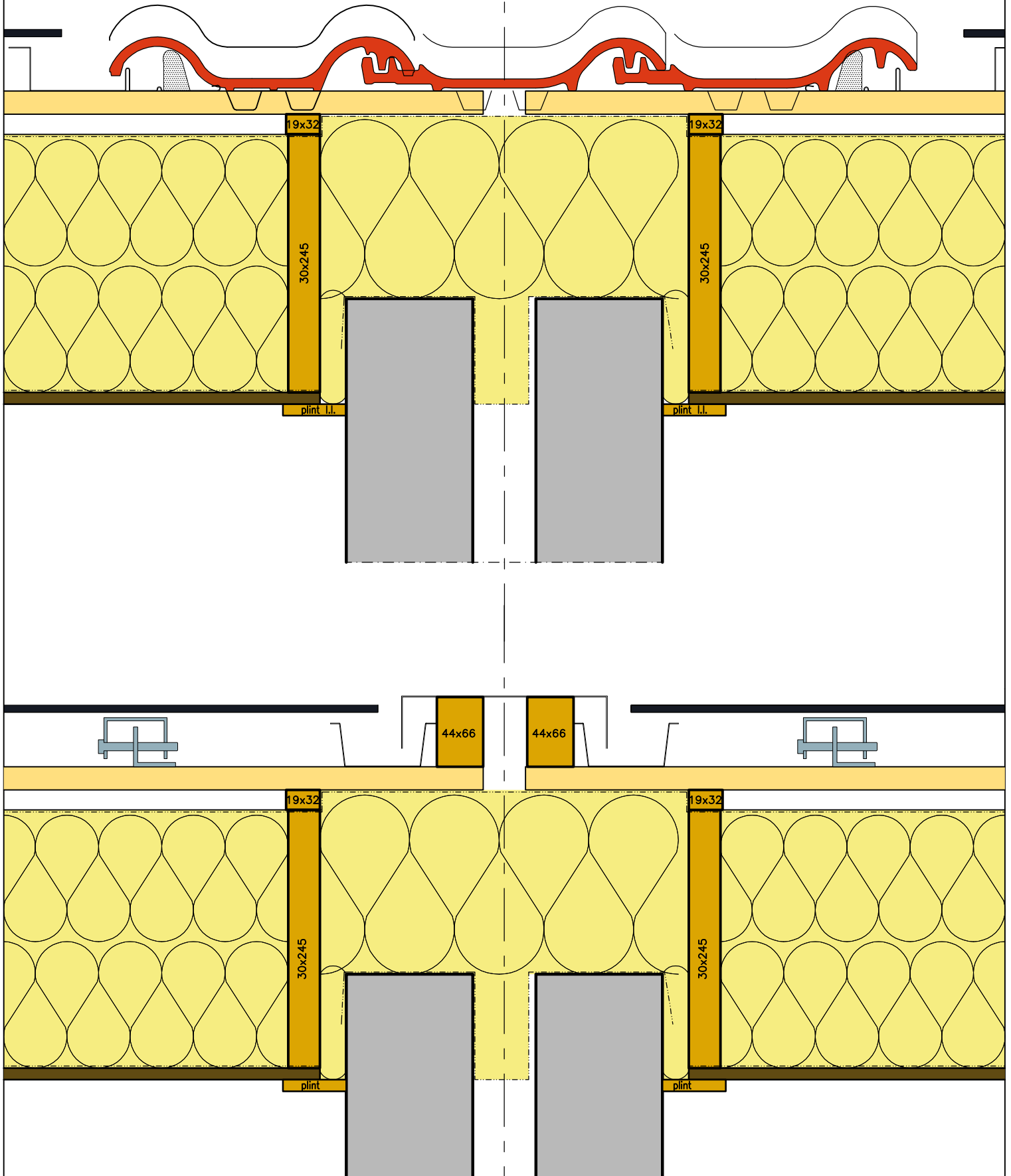

N8 Dakraam zijaansluiting

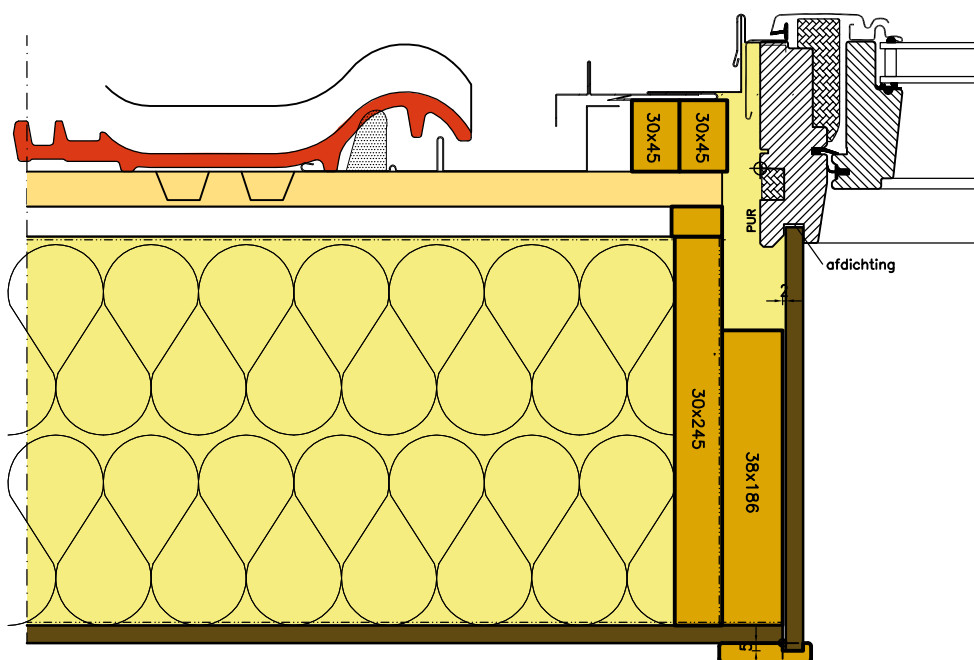
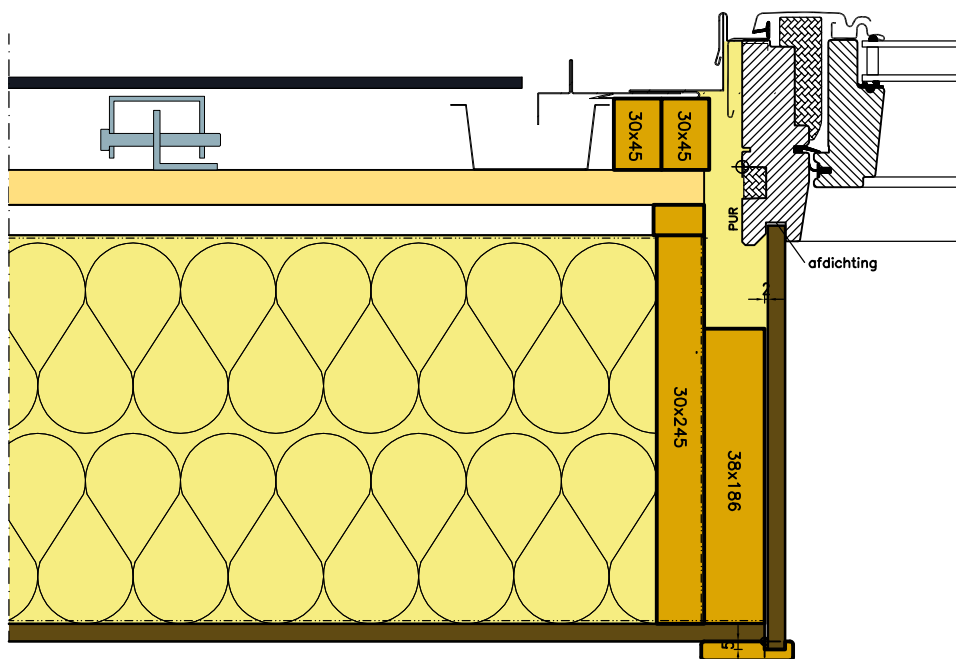

N9

Verticale aansluiting Navitect II

