

Detail:

- | | | | |
|----|---|-----|--|
| 1 | dak-muuraansluiting | 17 | dakgootconstructie |
| 2 | koppeling dakelementen | 18 | dakoverstekconstructie |
| 3 | woning scheidend koppeling dakvlak | 19 | hoekkeperconstructie |
| 4 | nok zadeldakconstructie | 20 | kilkeperconstructie |
| 5 | woningscheidende zakgootconstructie | 20a | kilkeperconstructie met kilgoot op panlatten |
| 6 | aansluiting knieschot-dakconstructie | 21 | aansluiting dakconstructie-kopgevel |
| 7 | plattendak-muuraansluiting | 22a | dakdoorvoer sparing rechthoekige sparing aansluiting |
| 8 | plattendak woningscheidend | 22b | dakdoorvoer sparing met EPS-isolatie |
| 9 | nok lessenaarsdakconstructie | 22c | dakdoorvoer sparing met PVC-buis |
| 10 | borstwering-dakconstructie | 23 | nok zadeldakconstructie (gording) |
| 11 | aansluiting vloer-dakconstructie | 24 | woning scheidend koppeling dakvlak (gording) |
| 12 | dakoverstek constructie | 25 | dakoverstekconstructie (gording) |
| 13 | woningscheidende nokconstructie zadeldak | 26 | koppeling dakelementen (gording) |
| 14 | zijkant dakraamconstructie | 27 | dakgootconstructie (gording) |
| 15 | bovenzijde aansluiting dakraamconstructie | 28 | aansluiting vloer-dakconstructie (gording) |
| 16 | onderzijde aansluiting dakraamconstructie | | |



Isolatie



Baksteen of dakpan



Beton / kalkzandsteen



Doorgesneden hout



Zijaanzicht hout



Spaanplaat

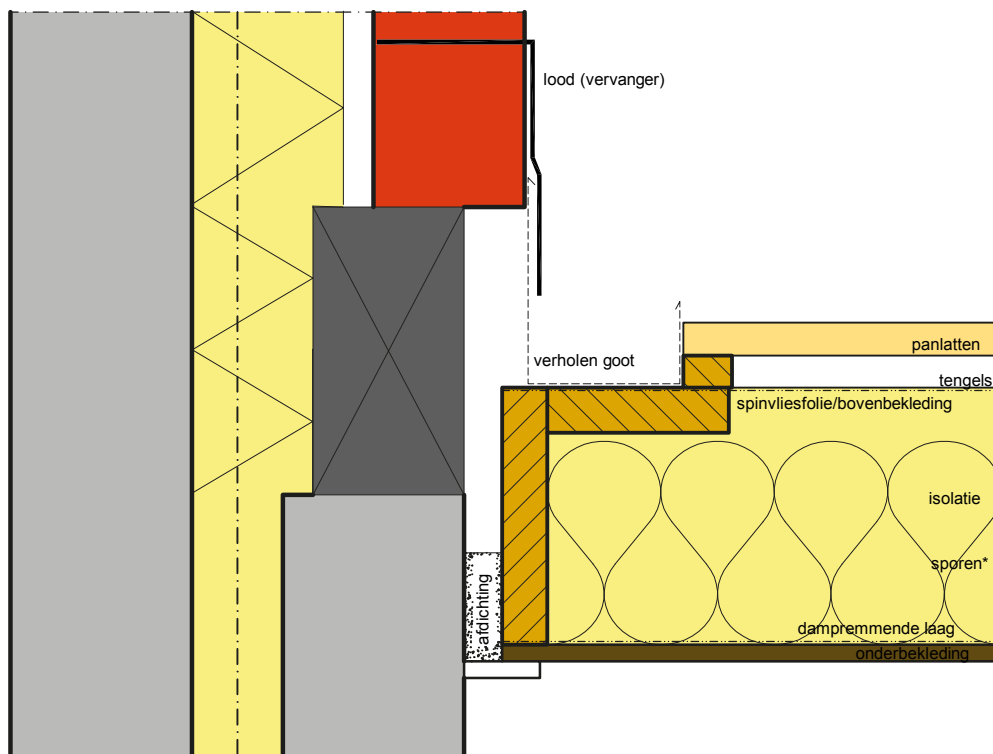
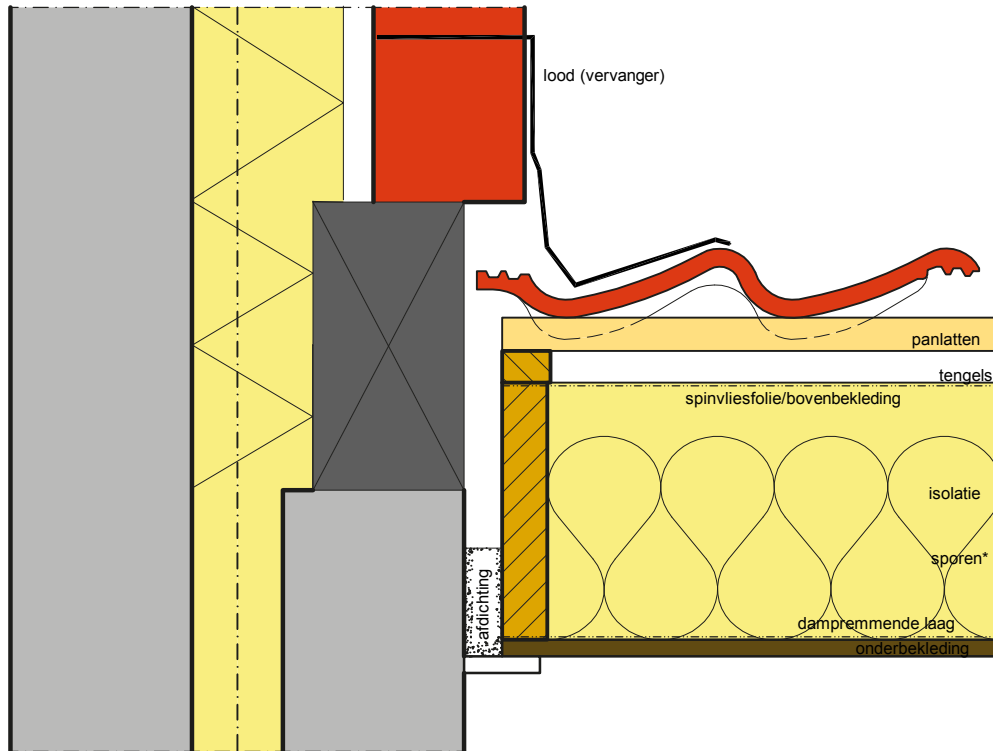

Detail 1: dak-muuraansluiting

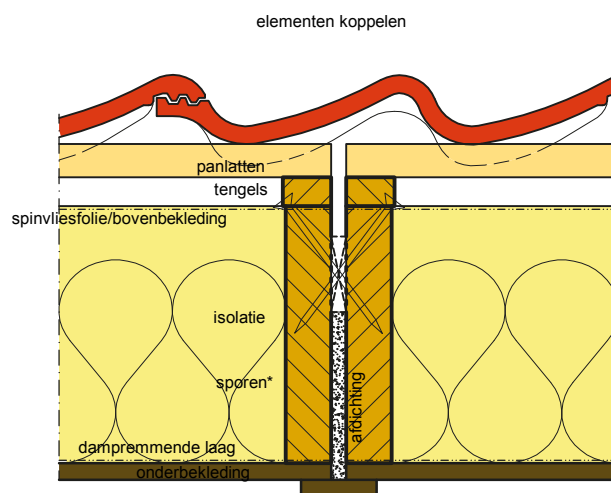

Detail 2: koppeling dakelementen

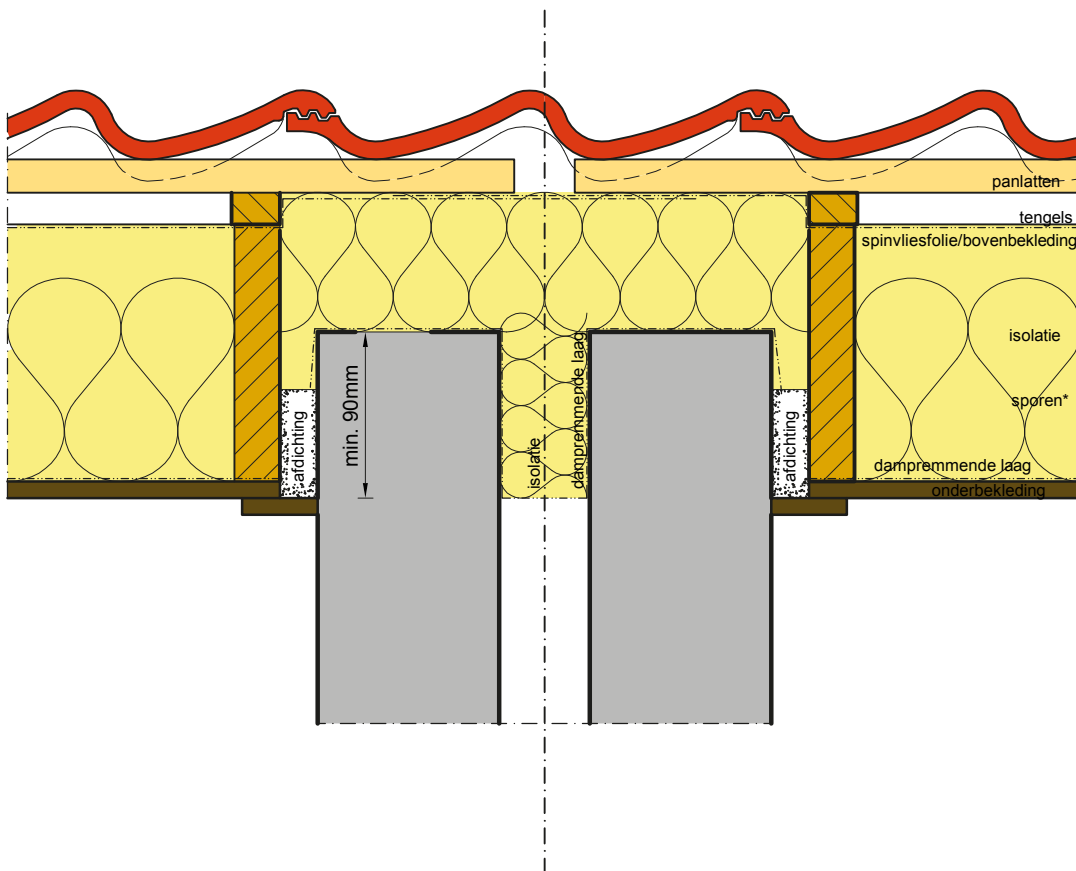

Detail 3: woning scheidend koppeling dakvlak

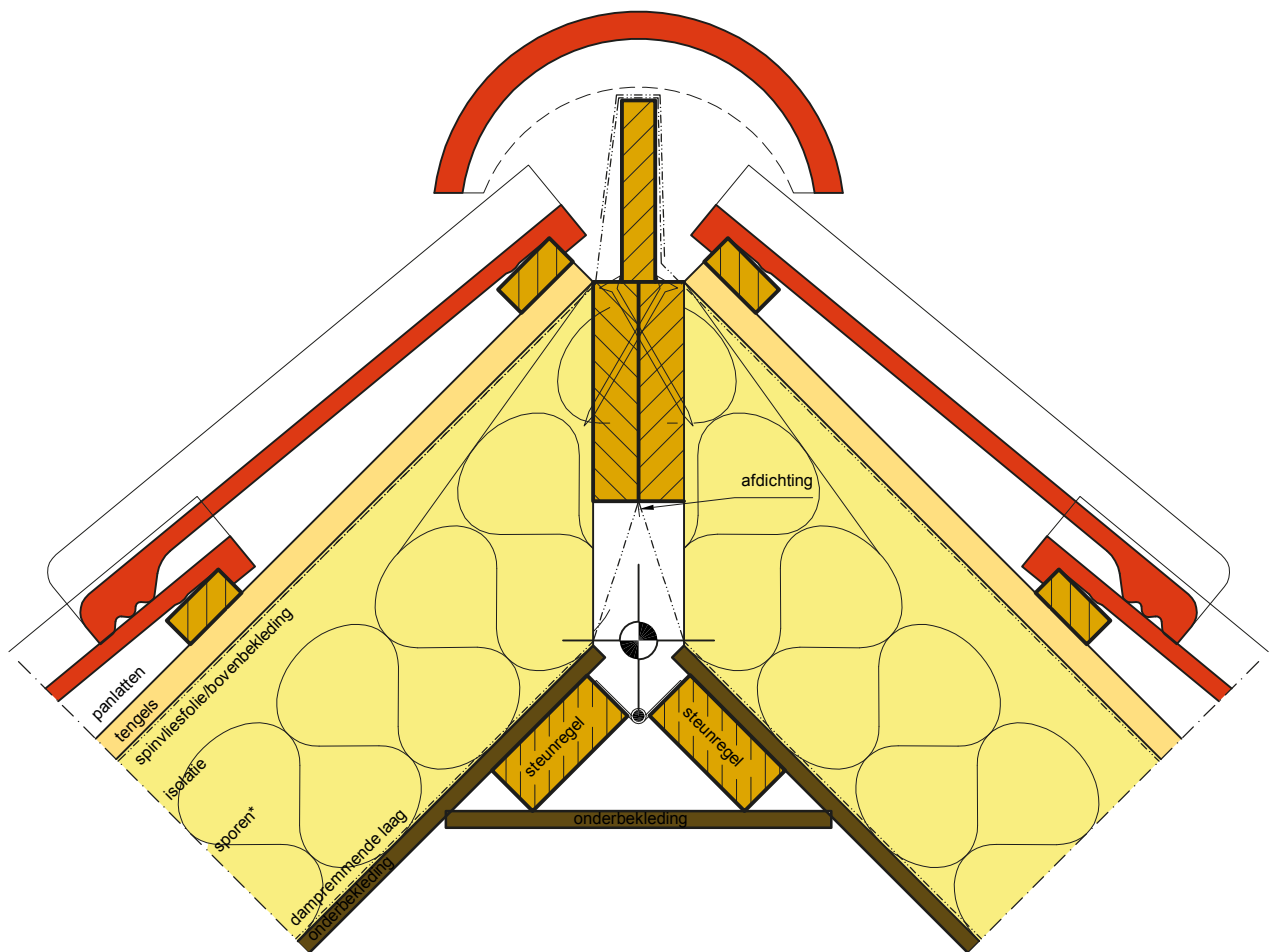

Detail 4: nok zadeldakconstructie

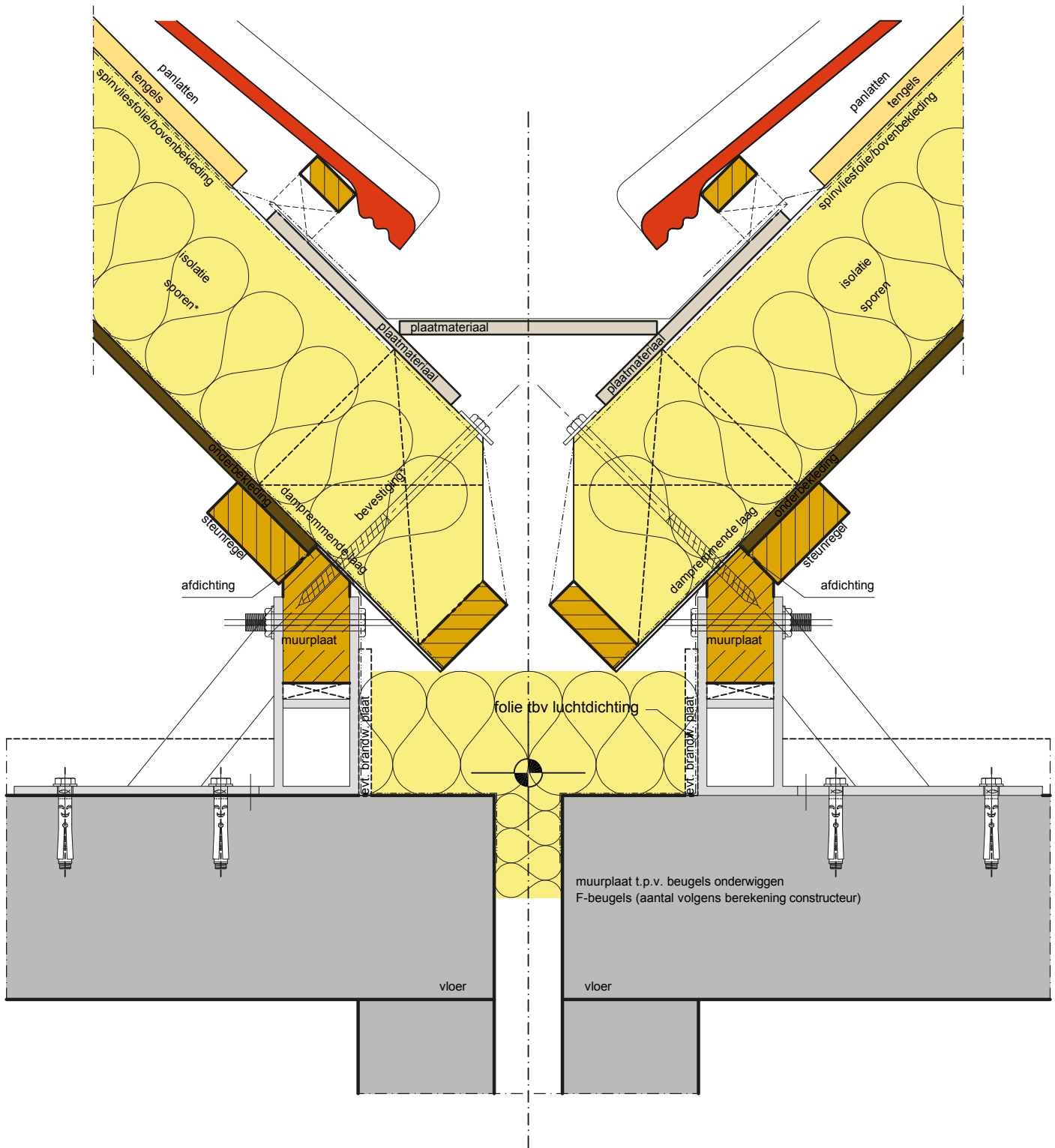

Detail 5: woningscheidende zakgootconstructie

*= volgens berekening constructeur

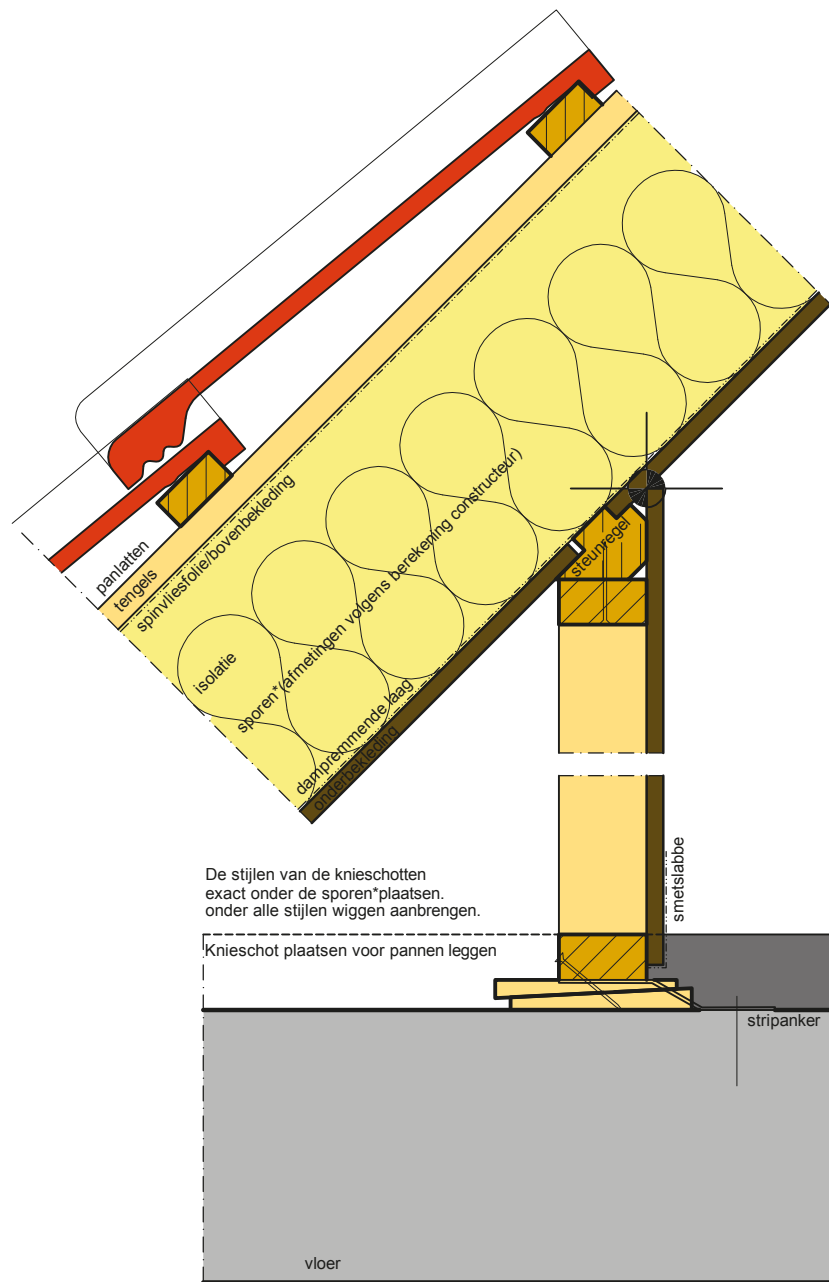

Detail 6: aansluiting knieschot-dakconstructie

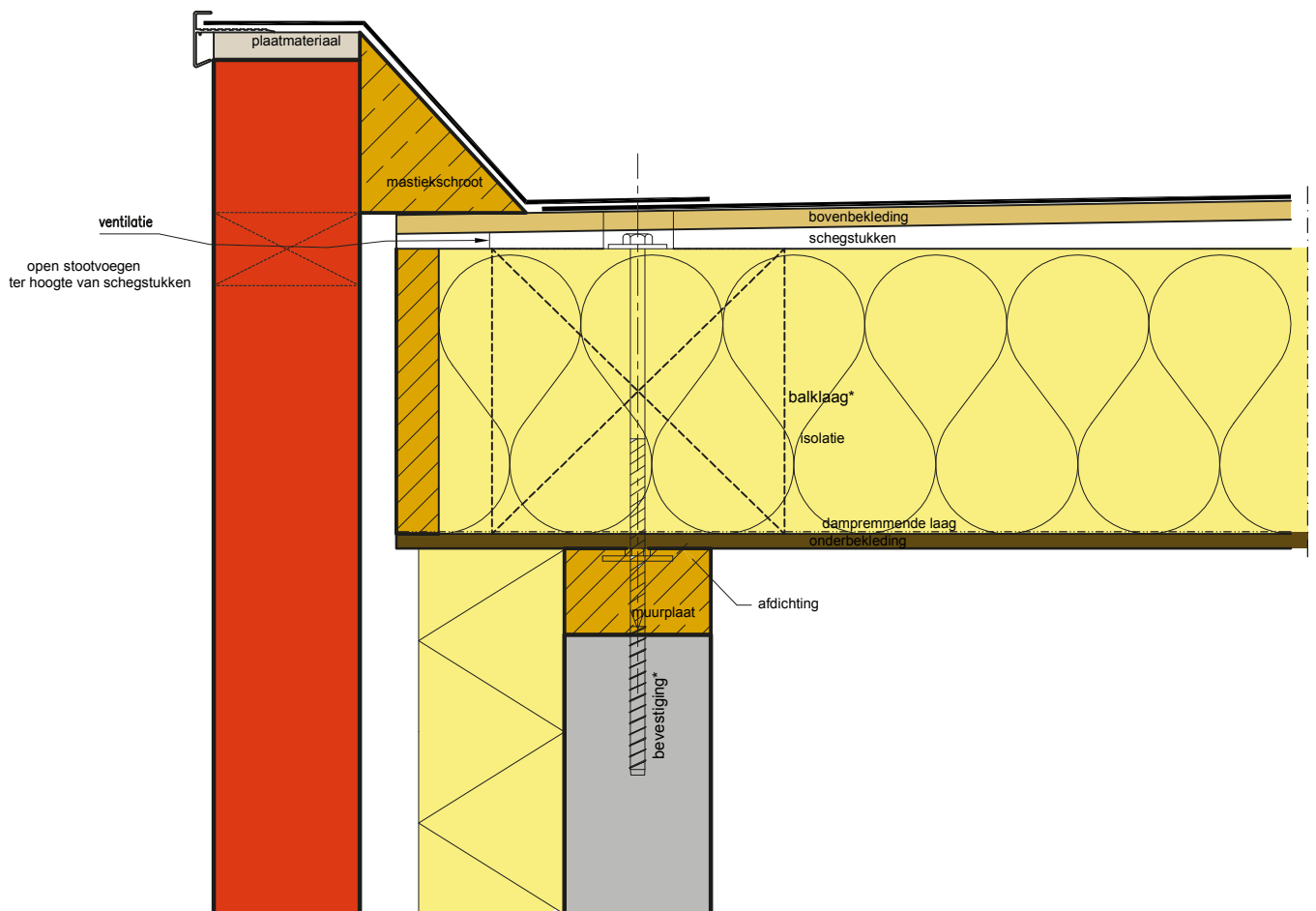

Detail 7: platdak muuraansluiting

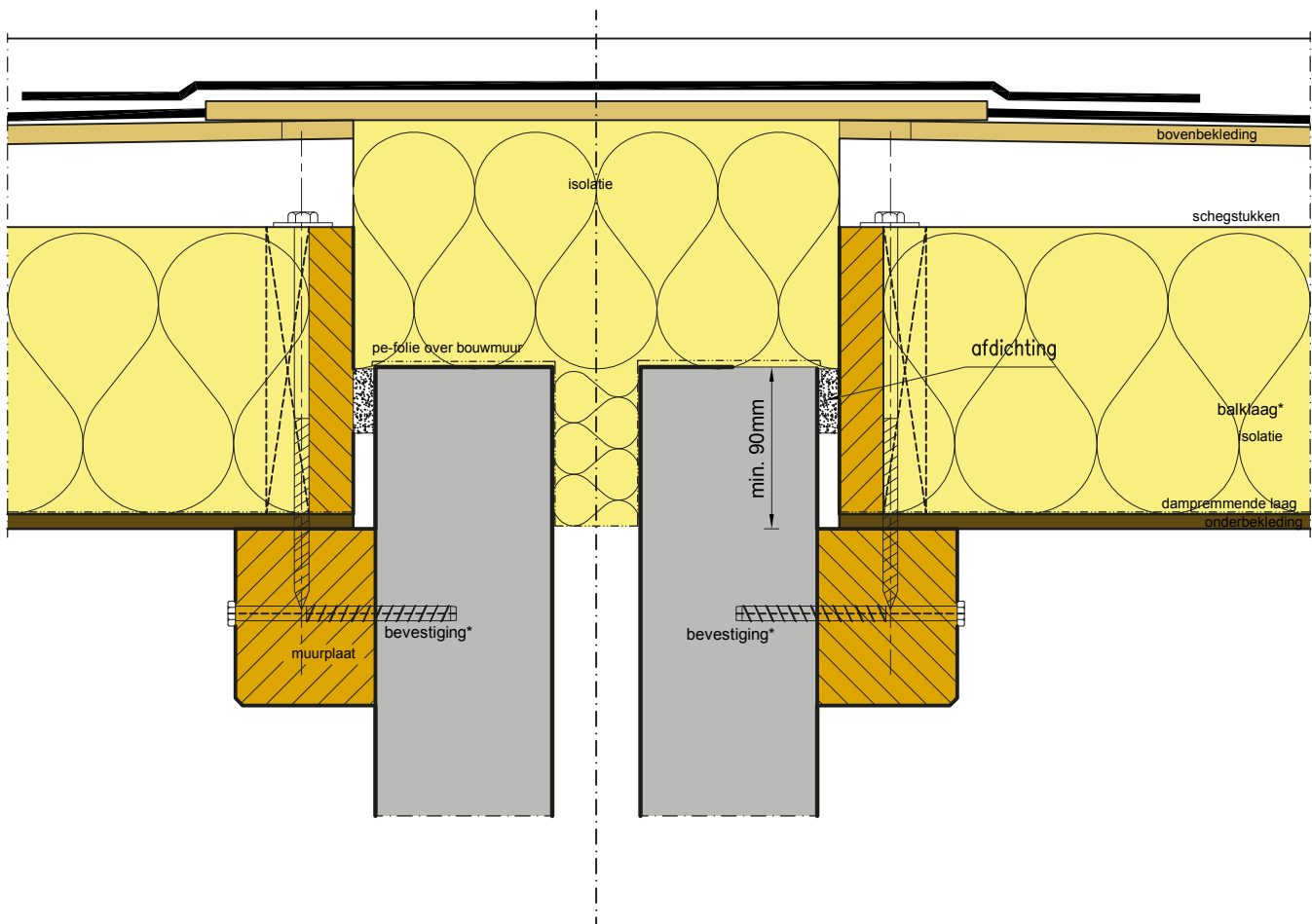

Detail 8: plattendak woningscheidend

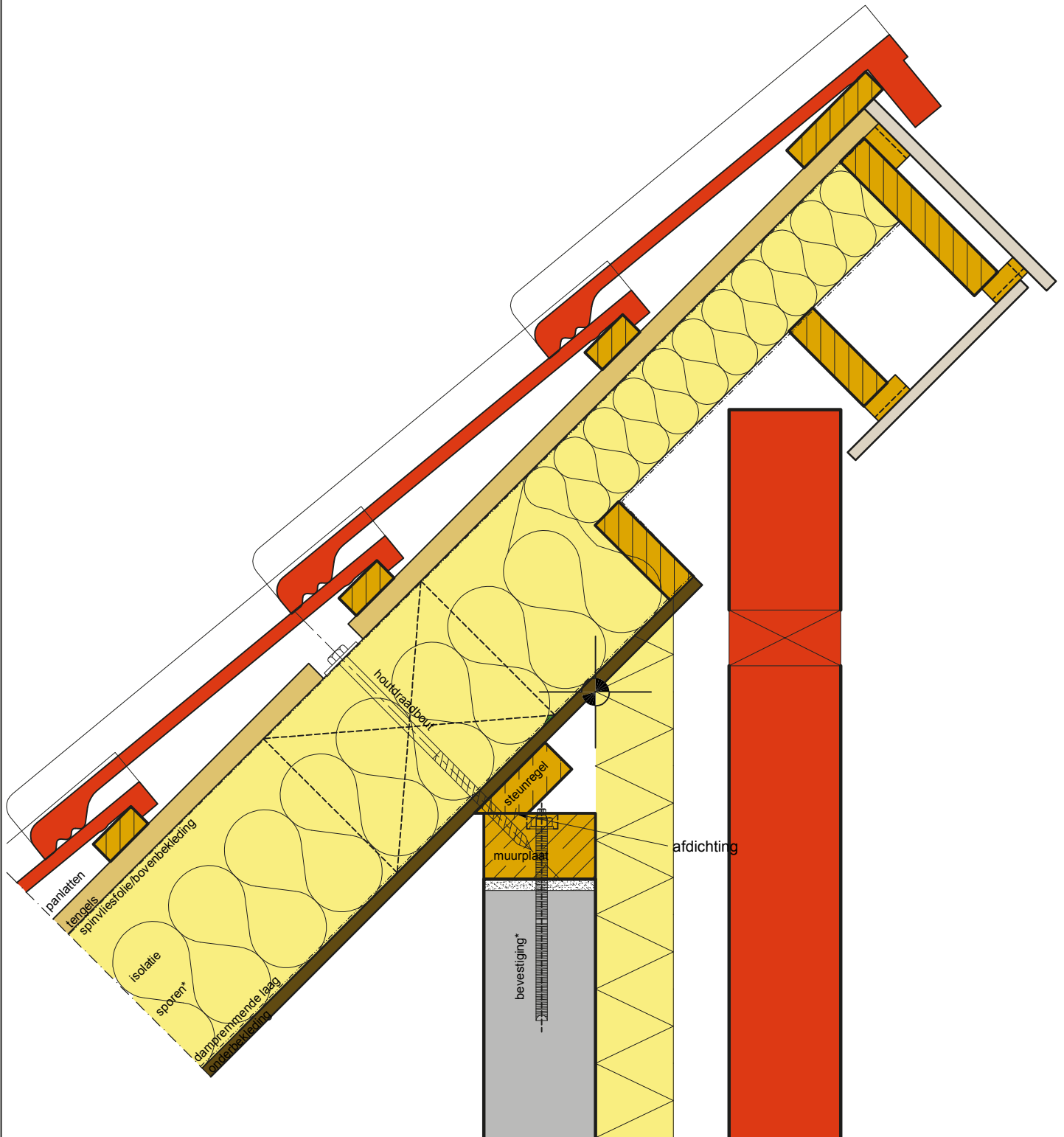

Detail 9: nok lessenaarsdakconstructie

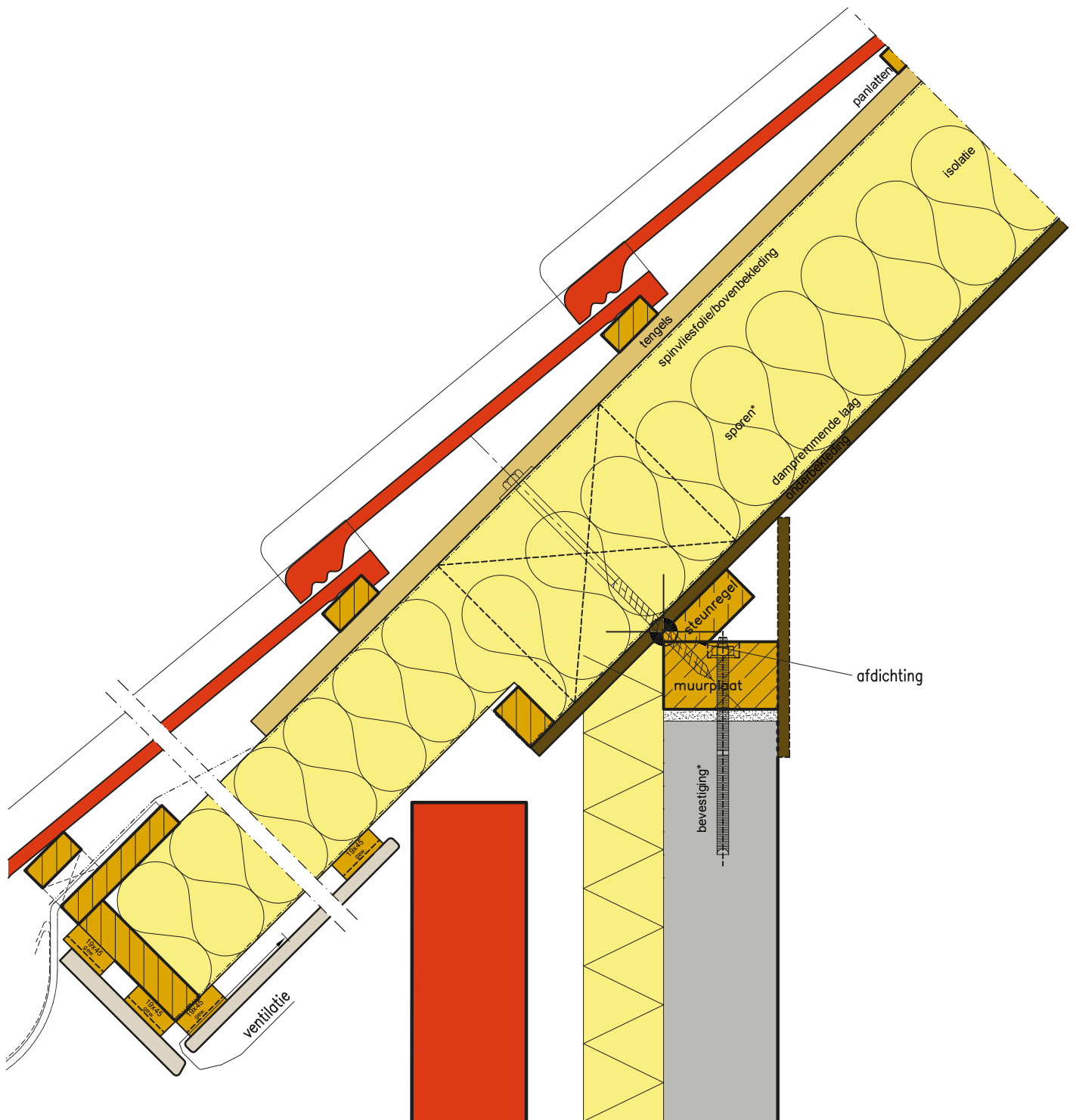

Detail 10: aansluiting borstwering-dakconstructie

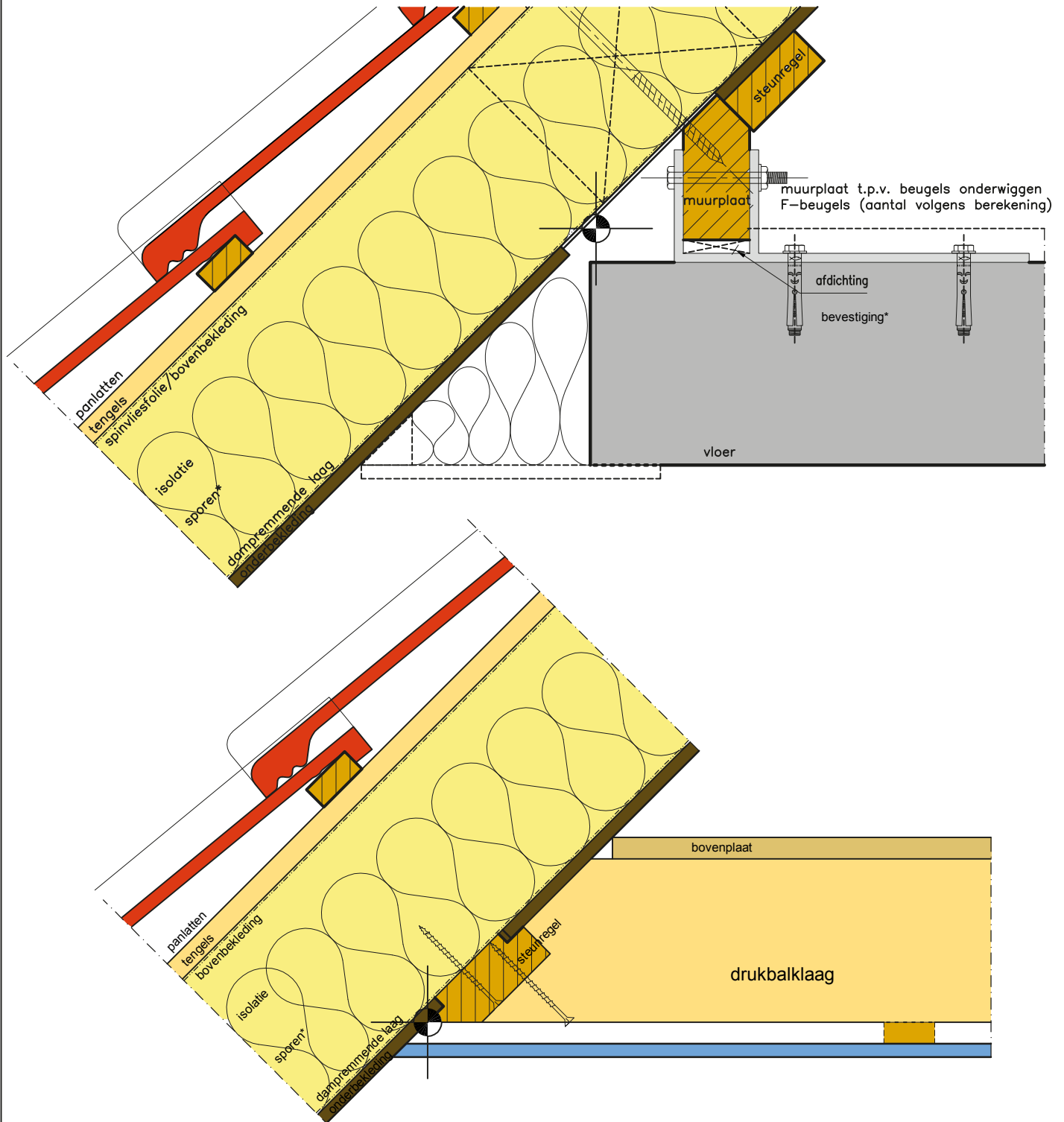

Detail 11: aansluiting vloer-dakconstructie

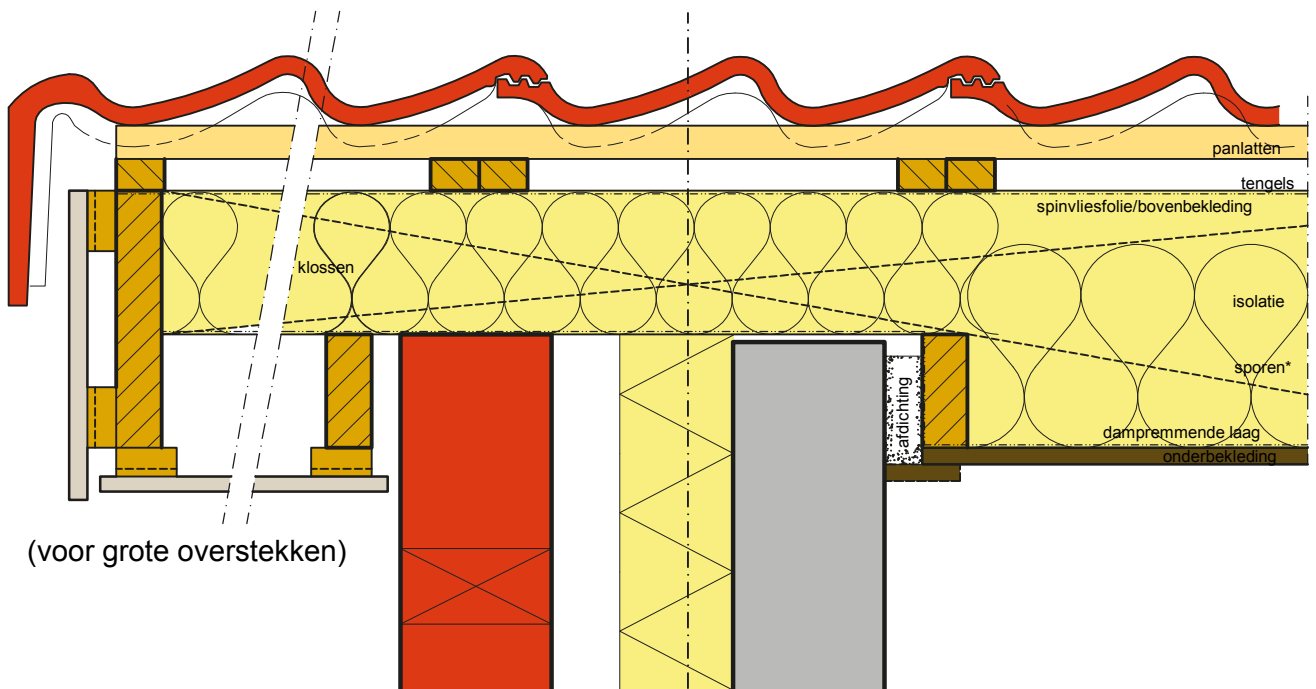
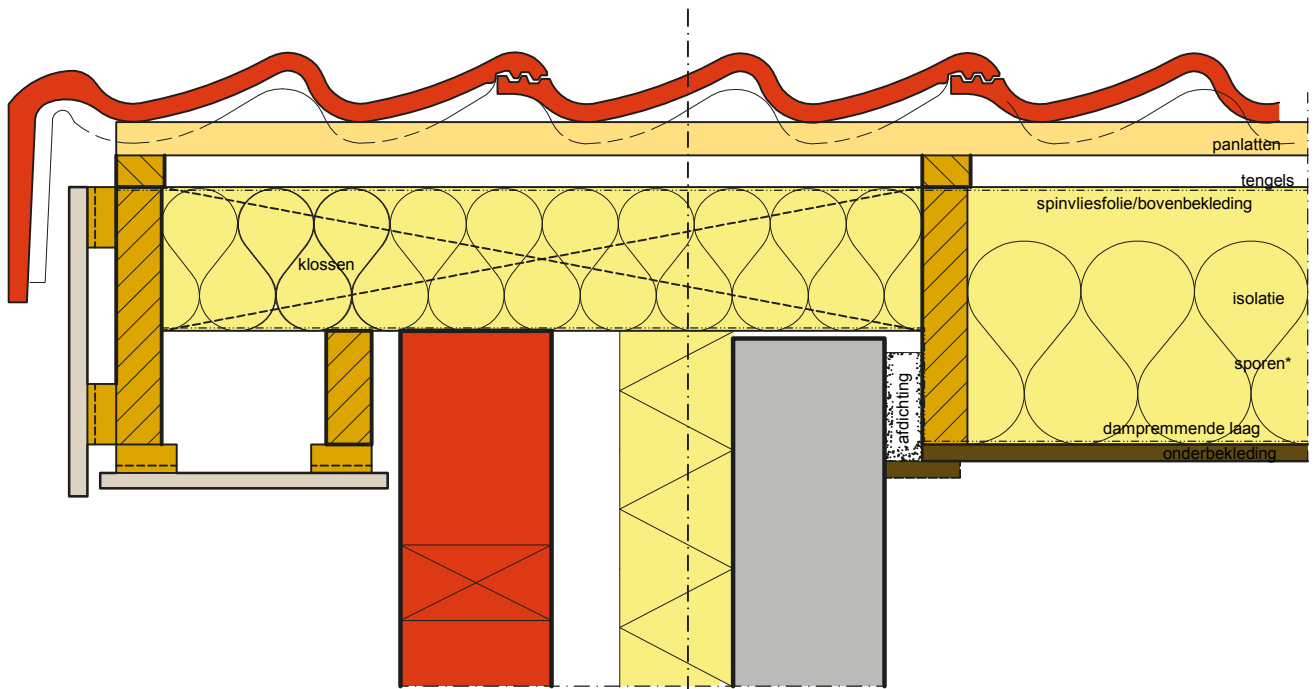

Detail 12: dakoverstek constructie

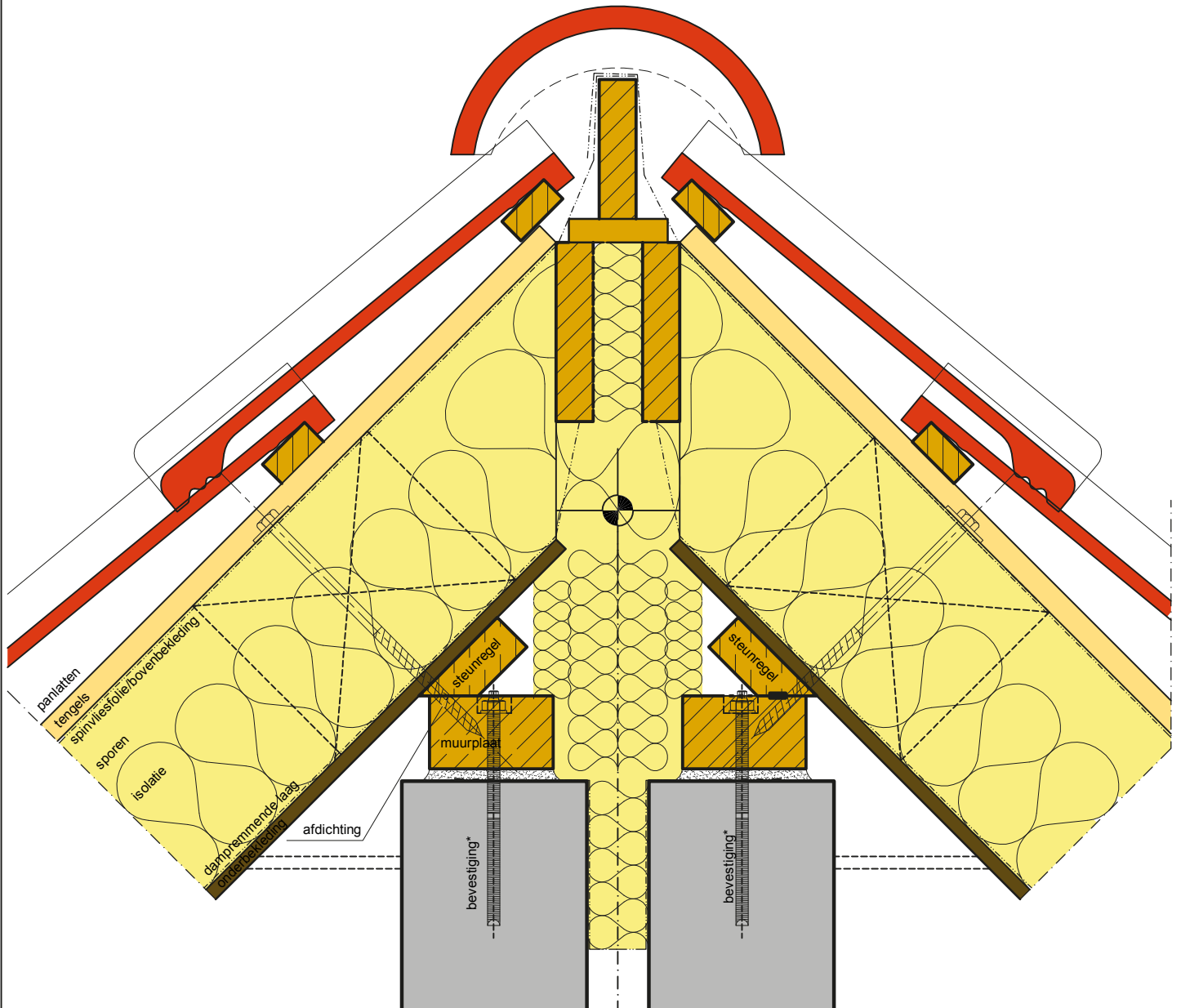

Detail 13: woningscheidende nokconstructie
zadeldak

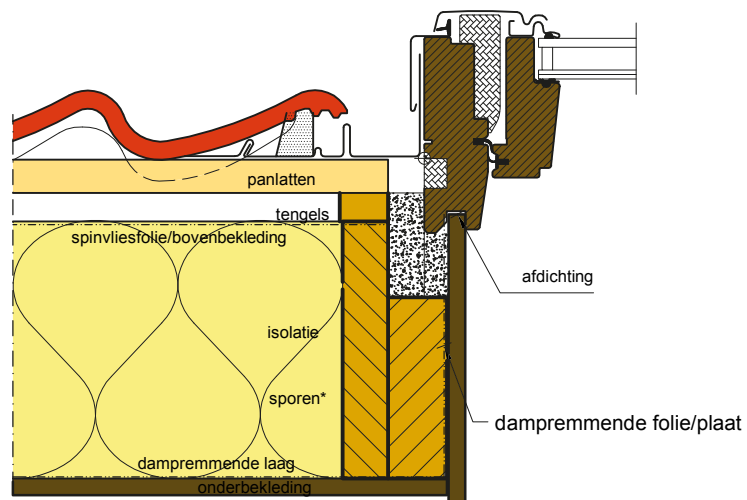

Detail 14: zijkant dakraamconstructie

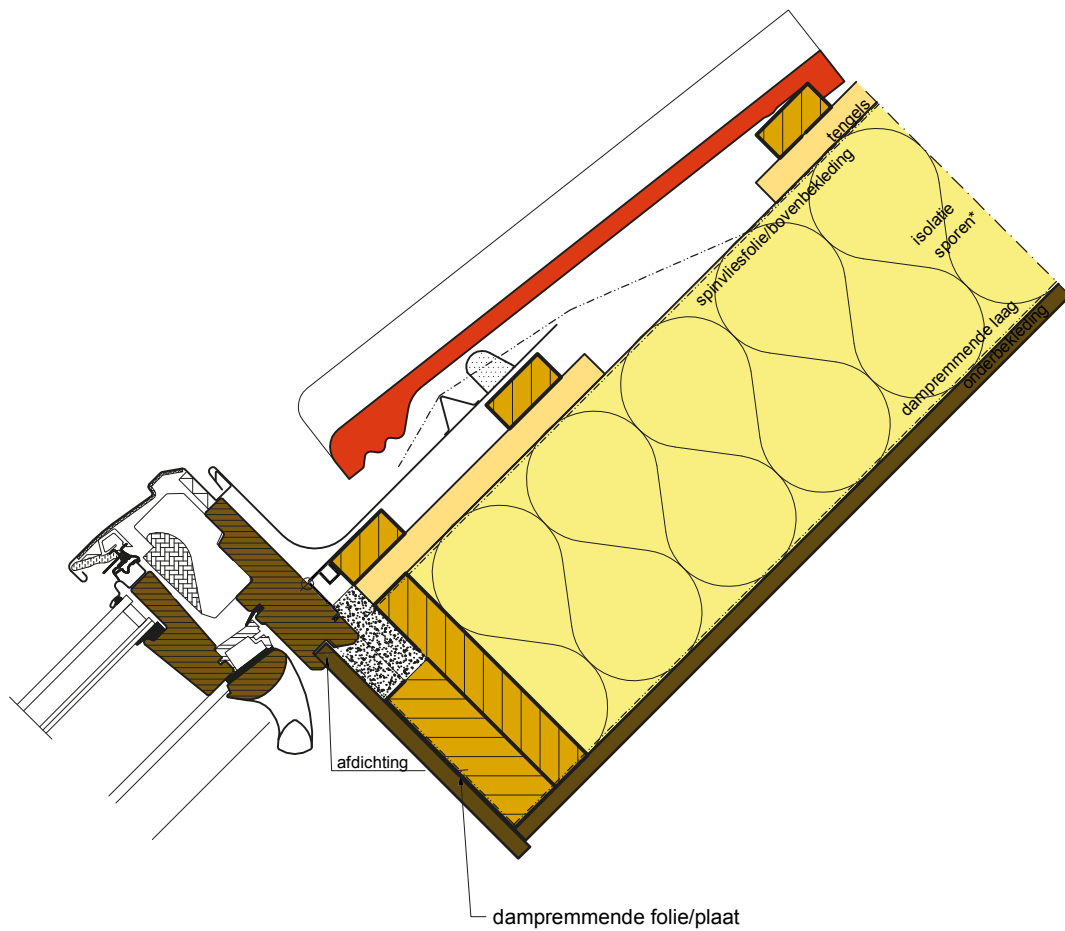

Detail 15: bovenzijde aansluiting dakraamconstructie

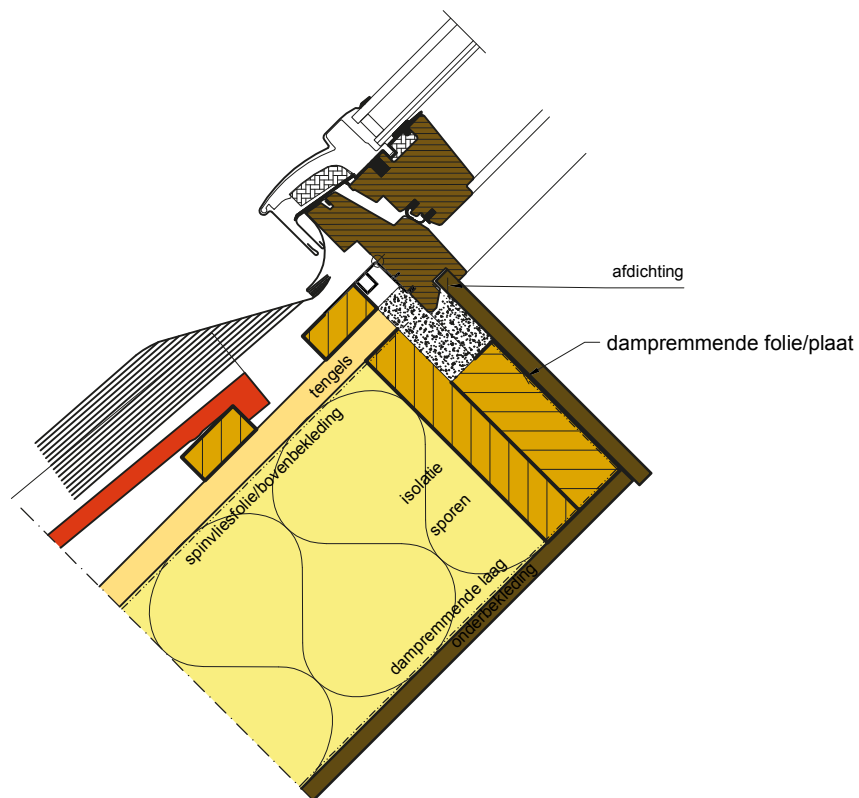

Detail 16: onderzijde aansluiting dakraamconstructie

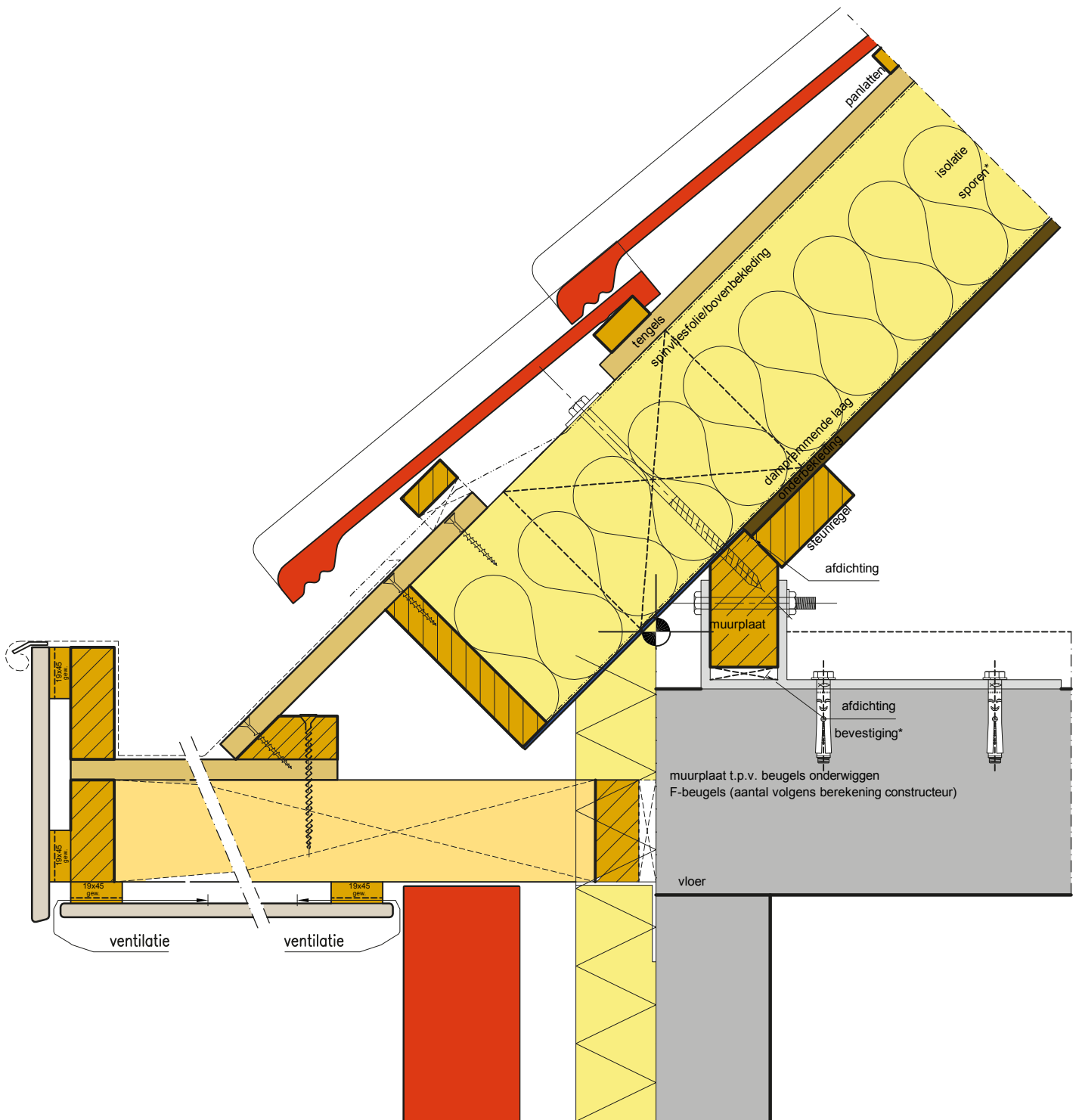

Detail 17: dakgootconstructie

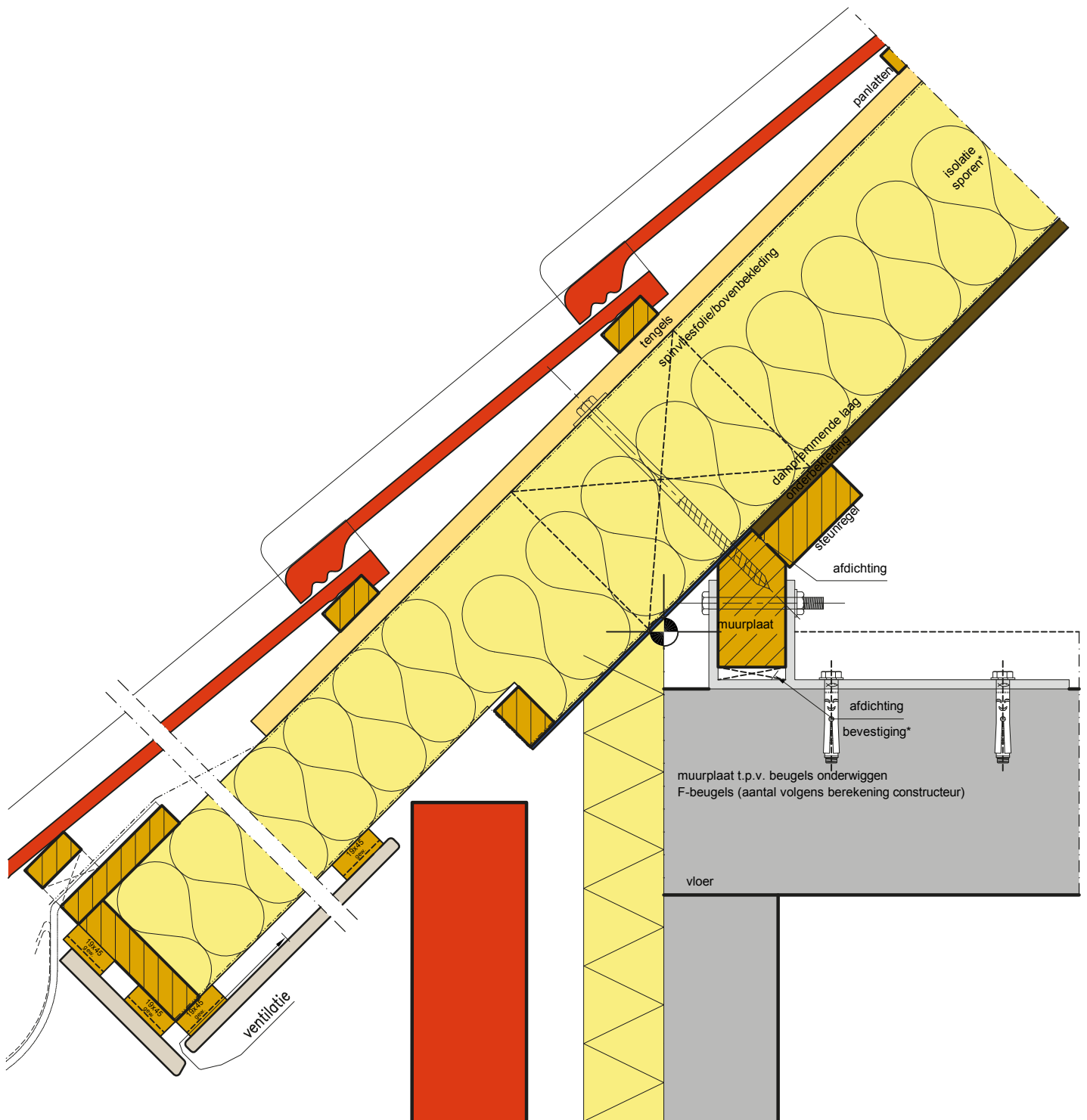

Detail 18: dakoverstekconstructie

*= volgens berekening constructeur

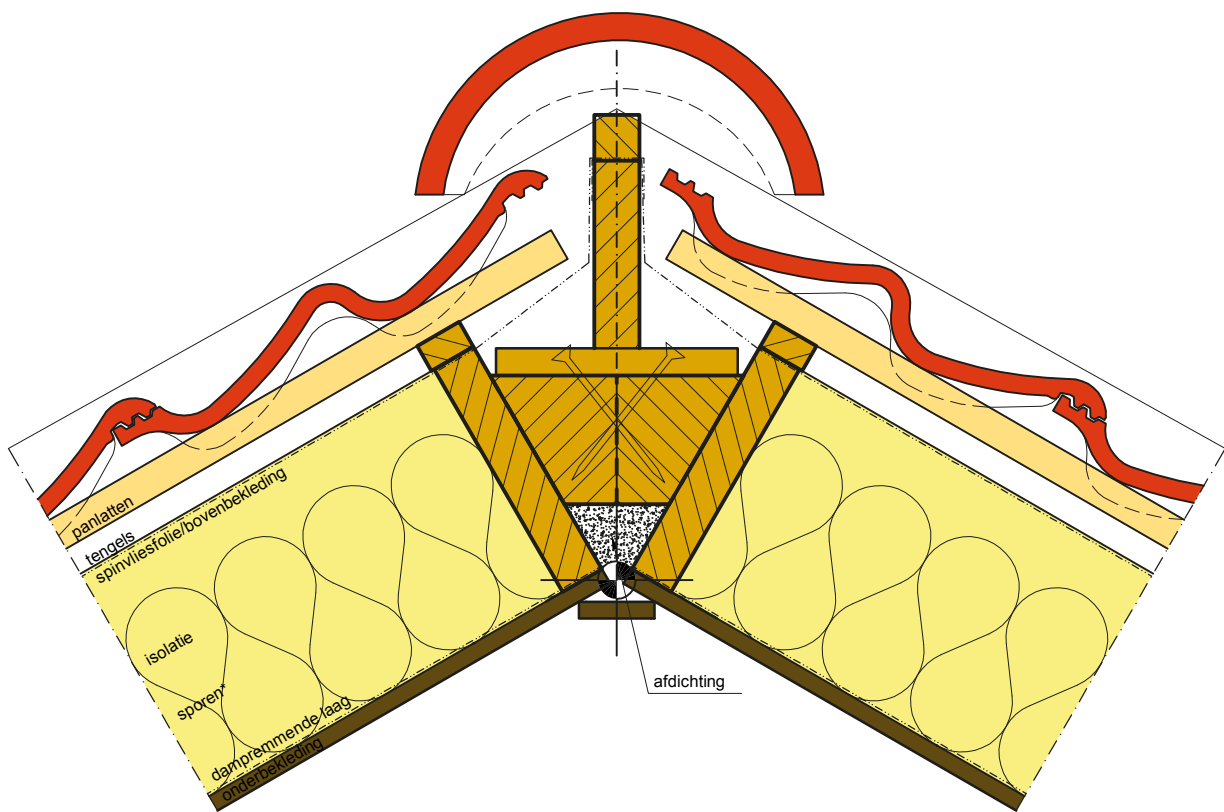

Detail 19: hoekkeperconstructie

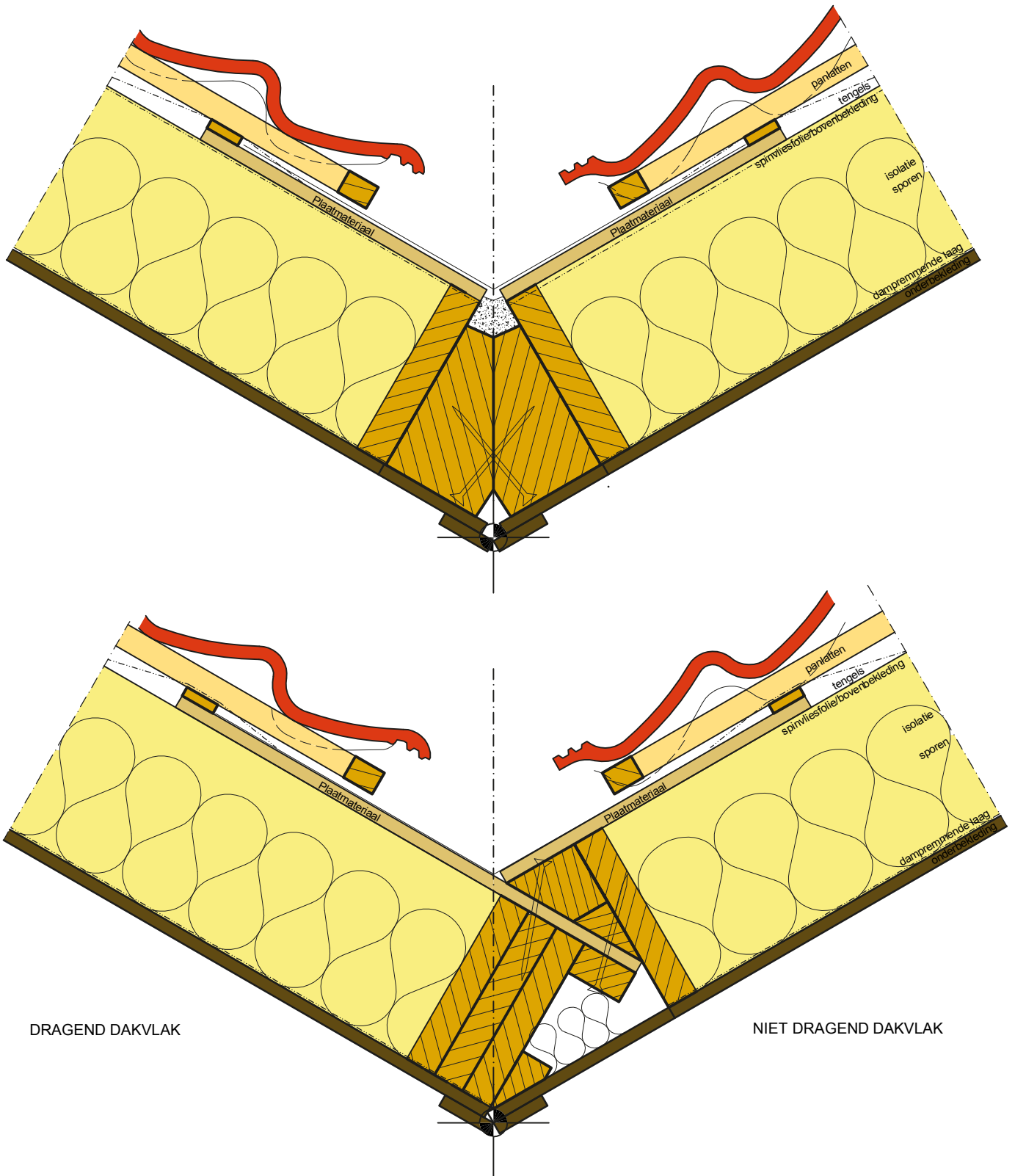

Detail 20: kilkeperconstructie

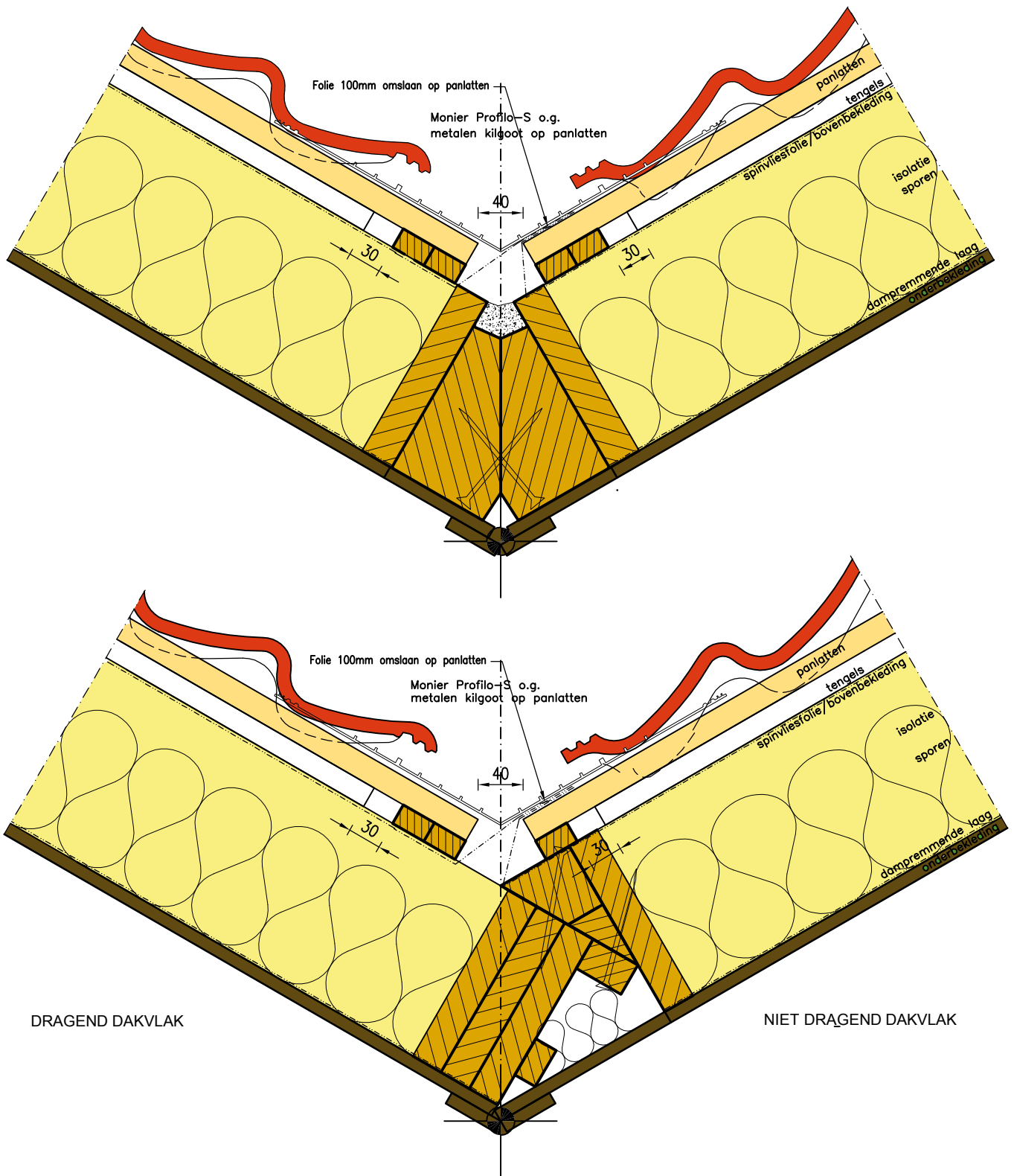

Detail 20a: kilkeperconstructie met kilgoot op panlatten

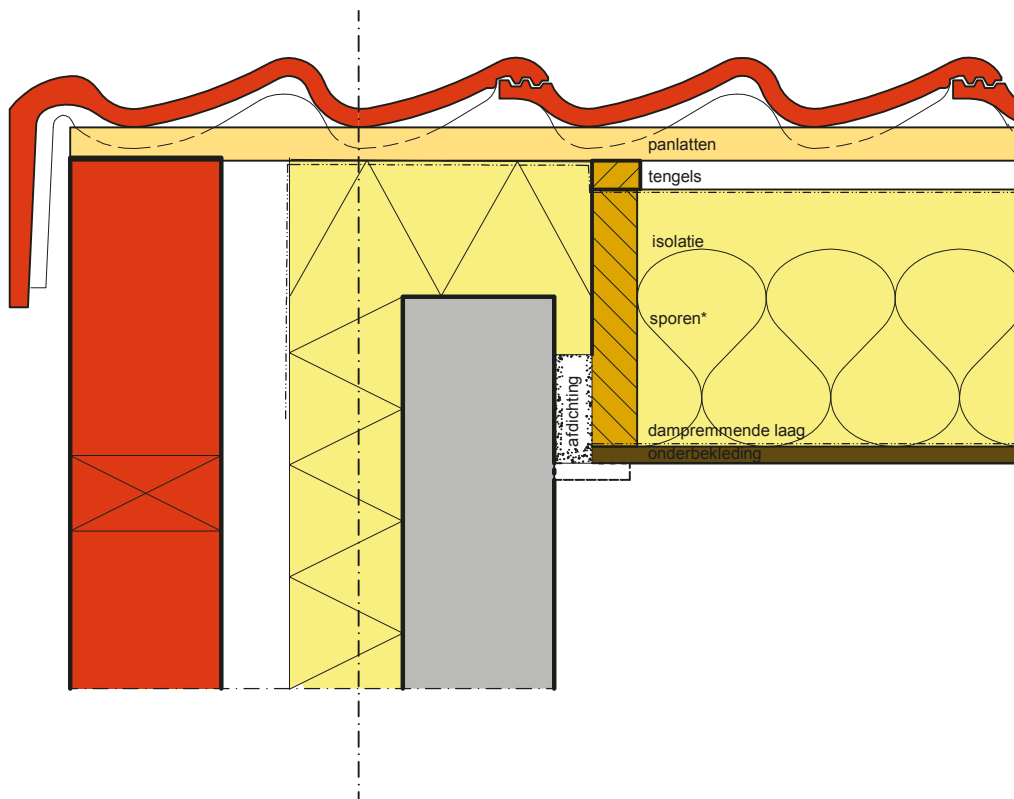

Detail 21: aansluiting dakconstructie-kopgevel

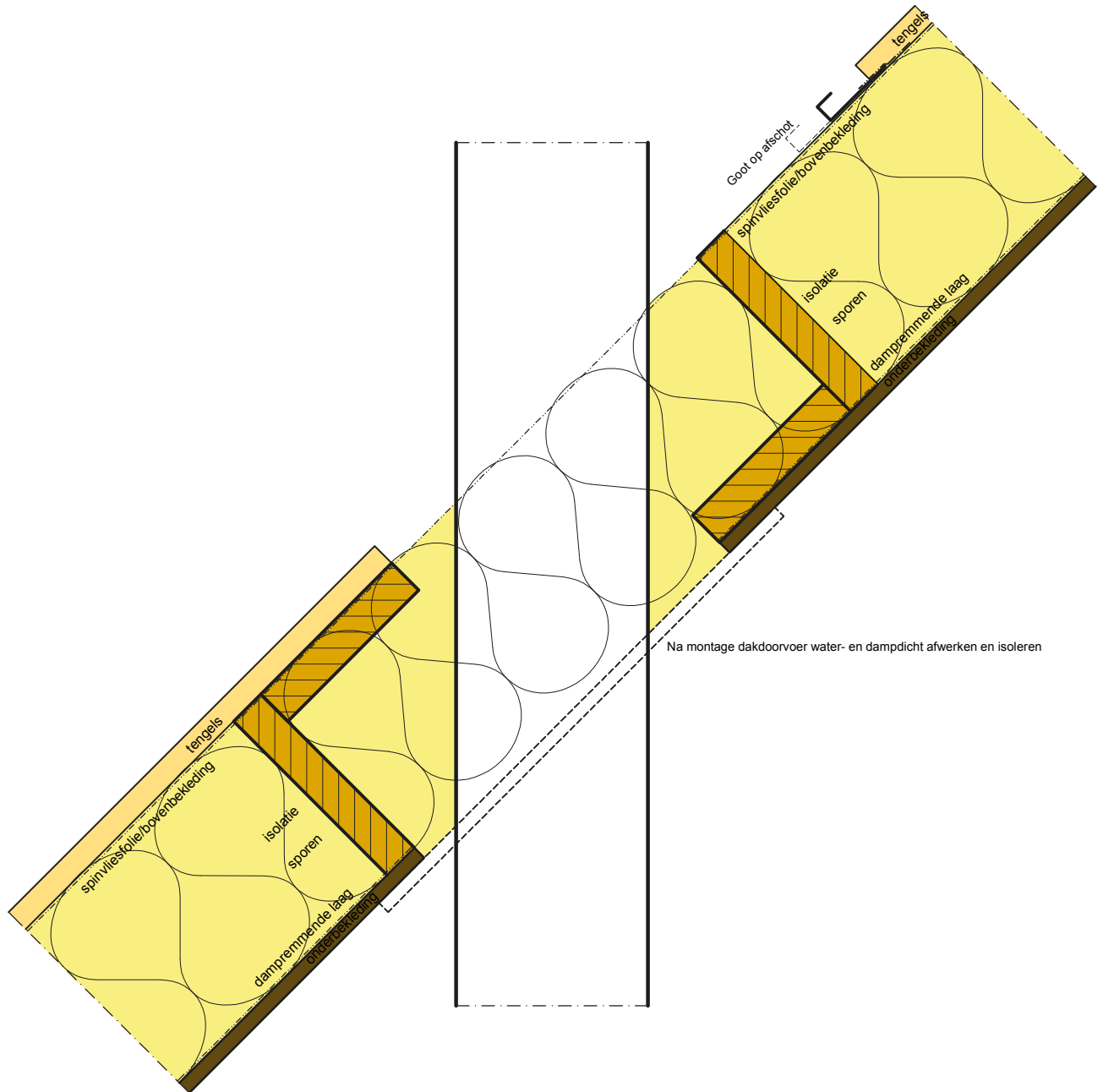

Detail 22a: dakdoorvoer sparing rechthoekige sparing

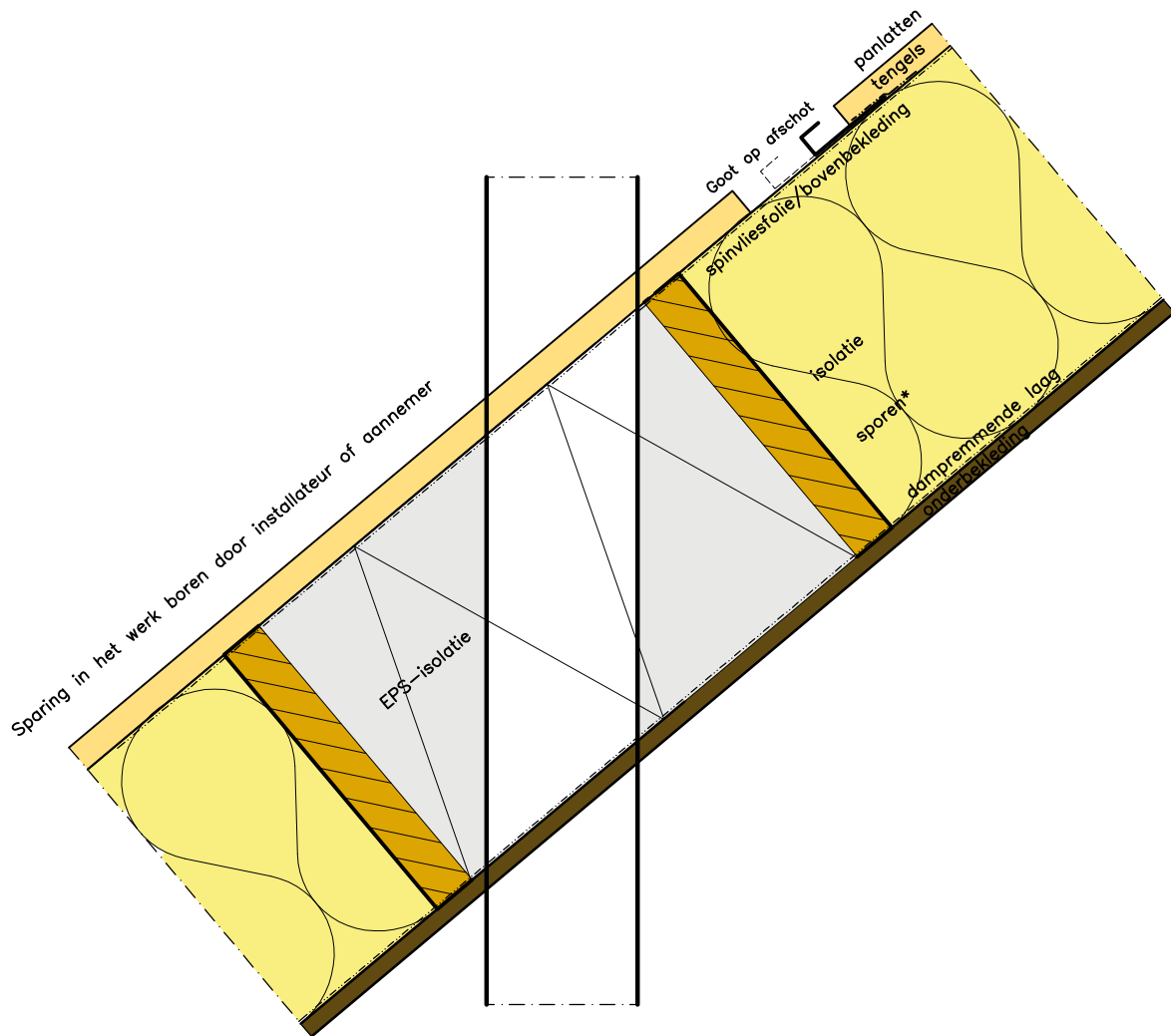

Detail 22b: Dakdoorvoer sparing met EPS-isolatie (dakdoorvoer boren)

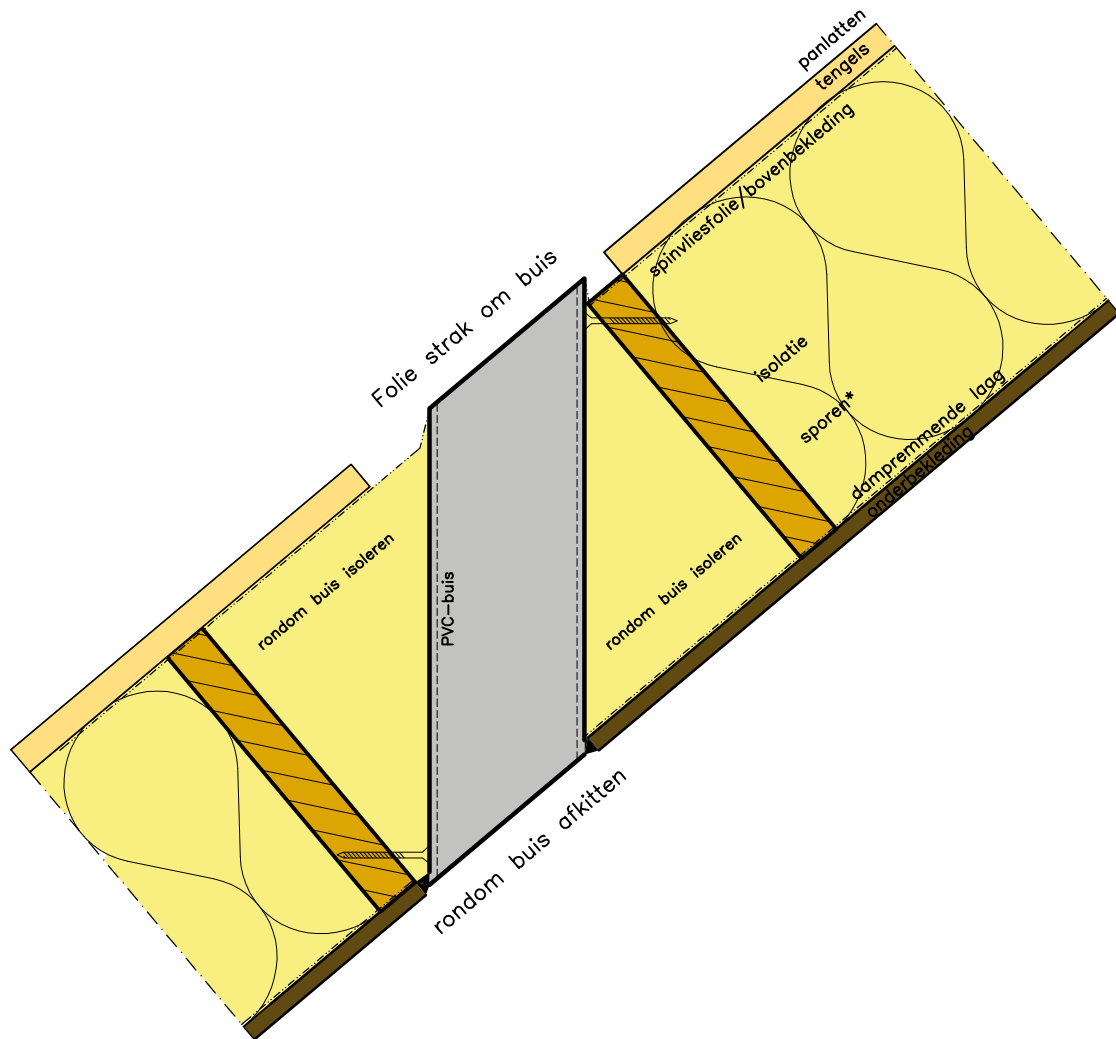

Detail 22c: Dakdoorvoer sparing met PVC-buis

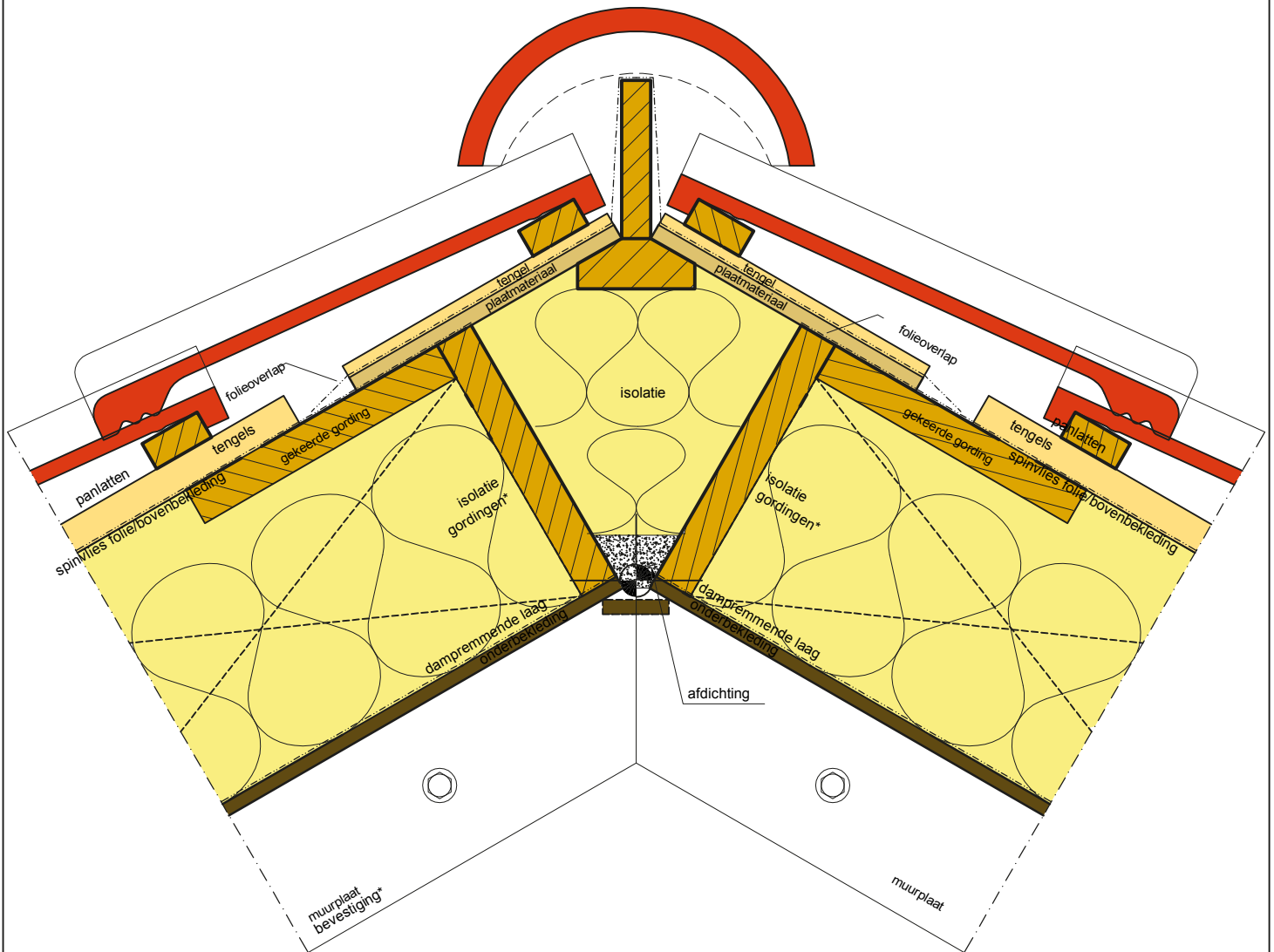

Detail 23: nok zadeldakconstructie (gording)

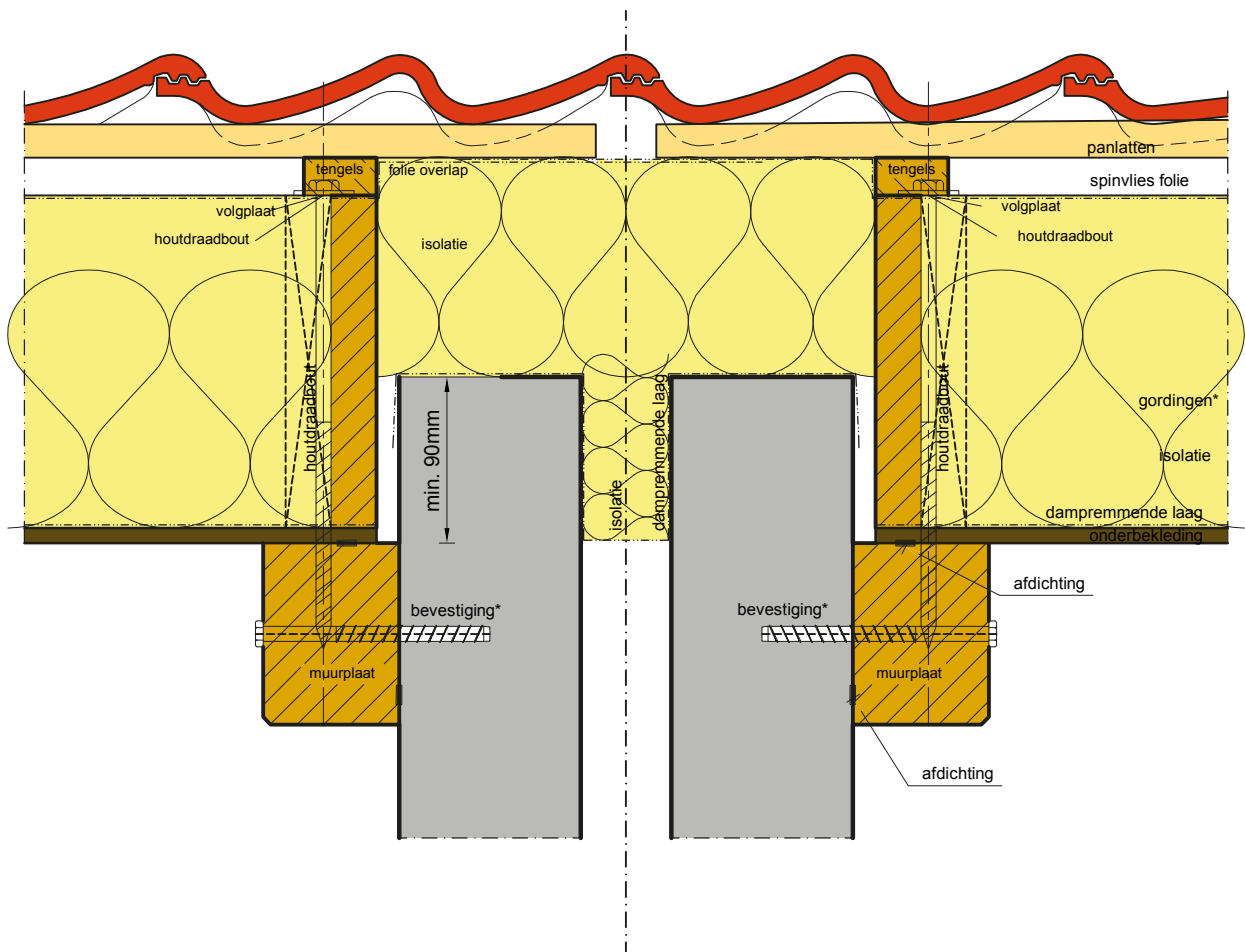

Detail 24: woning sheidend koppeling dakvlak
(gording)

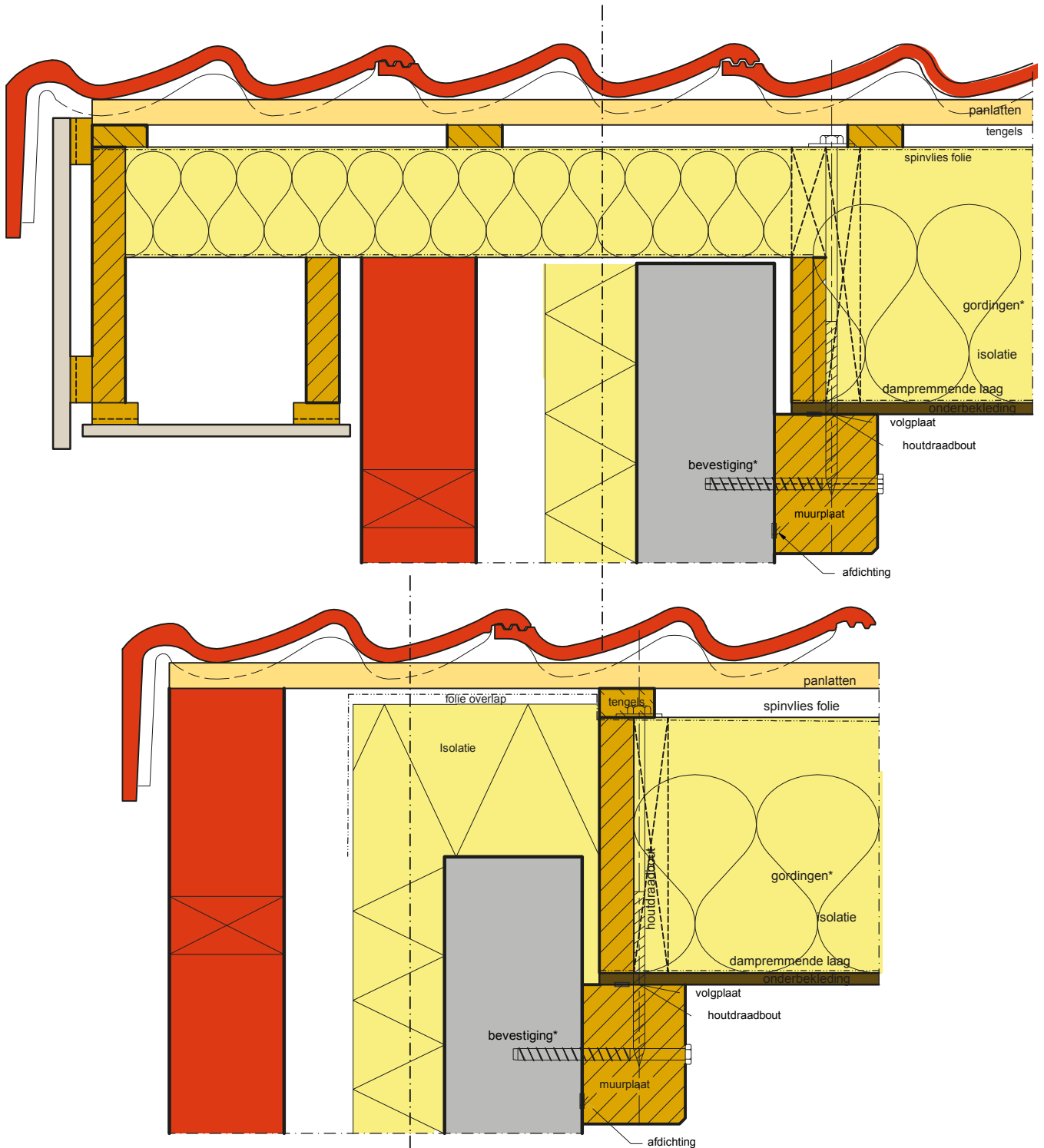

Detail 25: dakoverstekconstructie (gording)

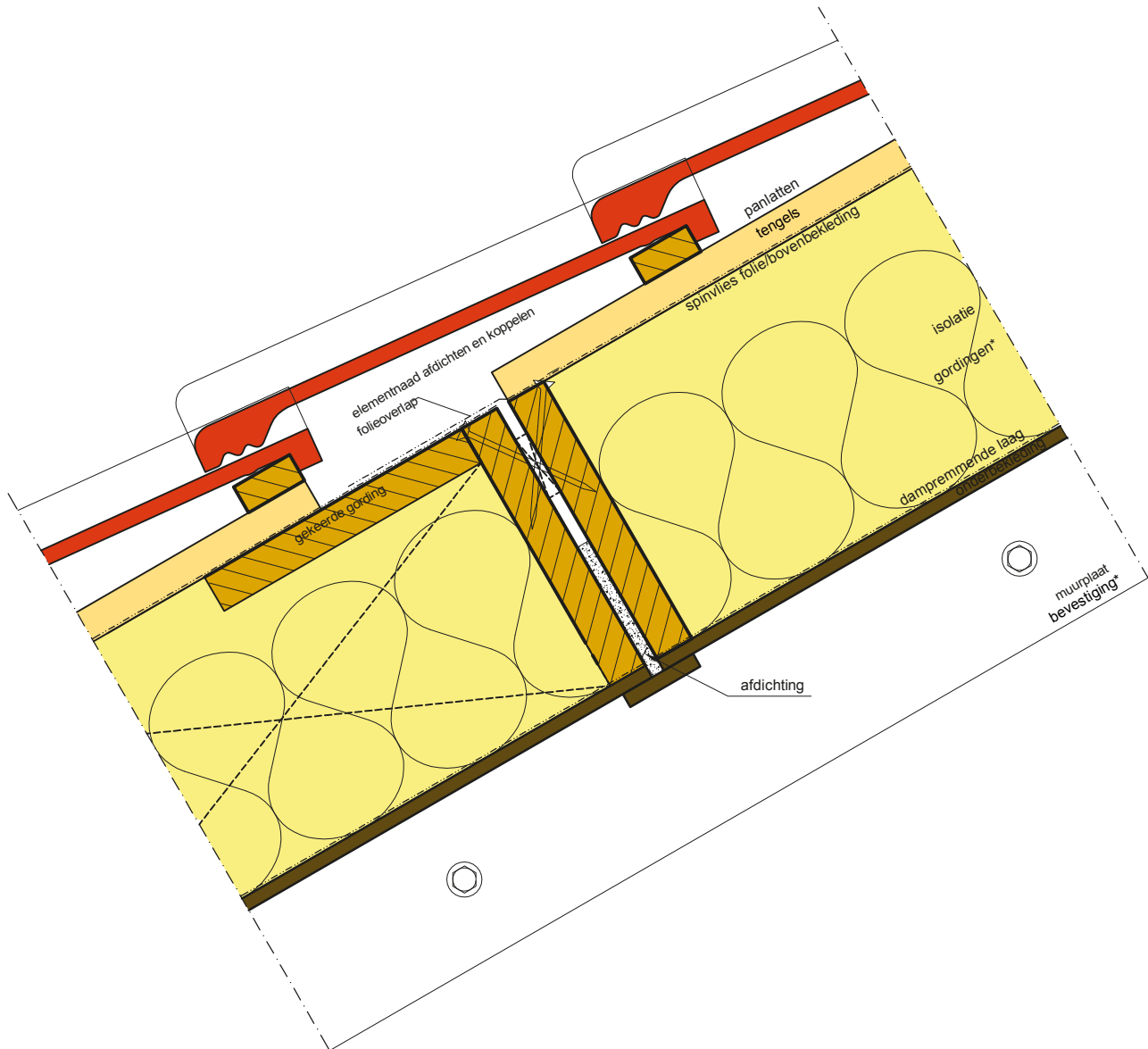

Detail 26: koppeling dakelementen (gording)

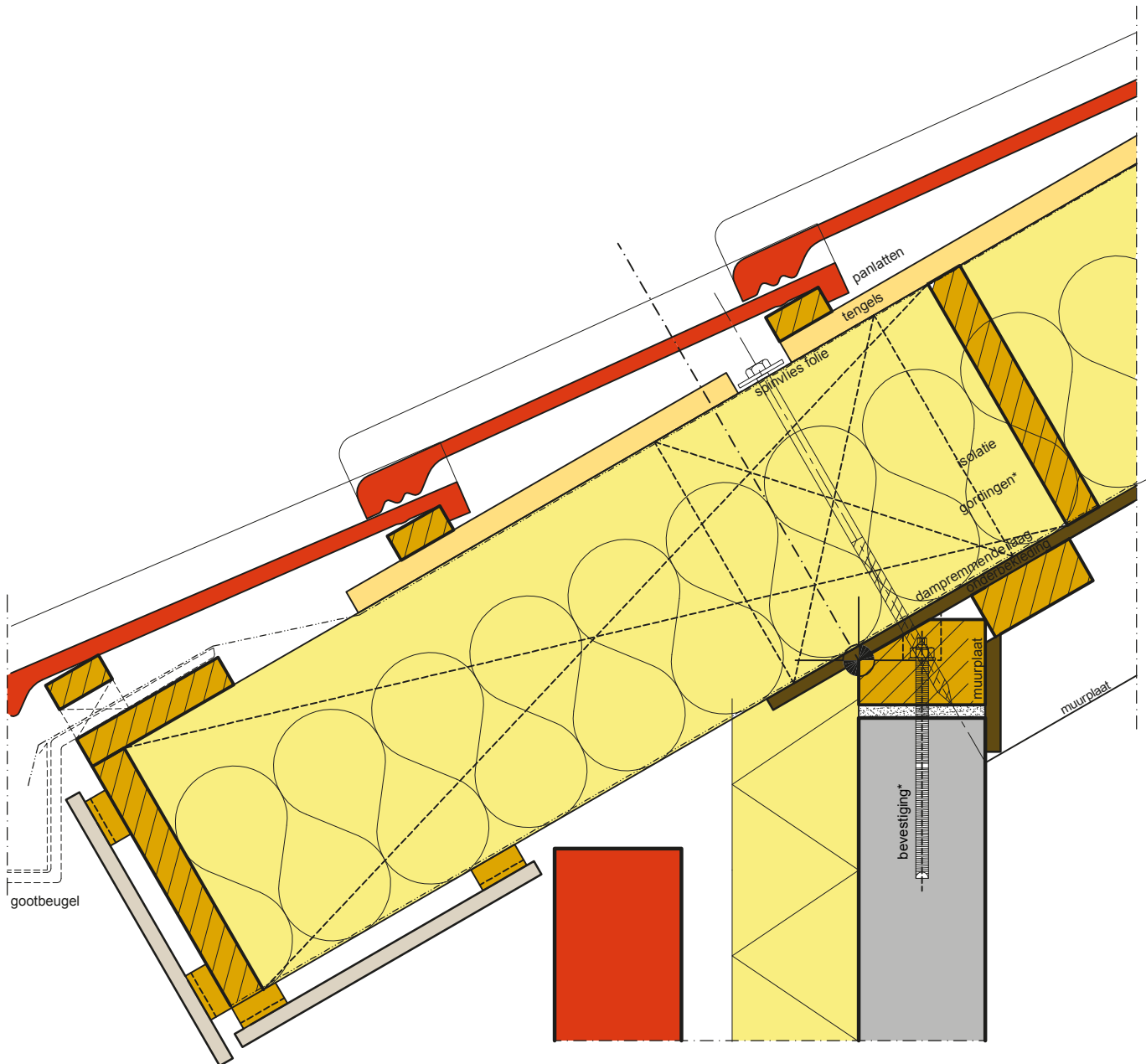

Detail 27: dakgootconstructie (gording)

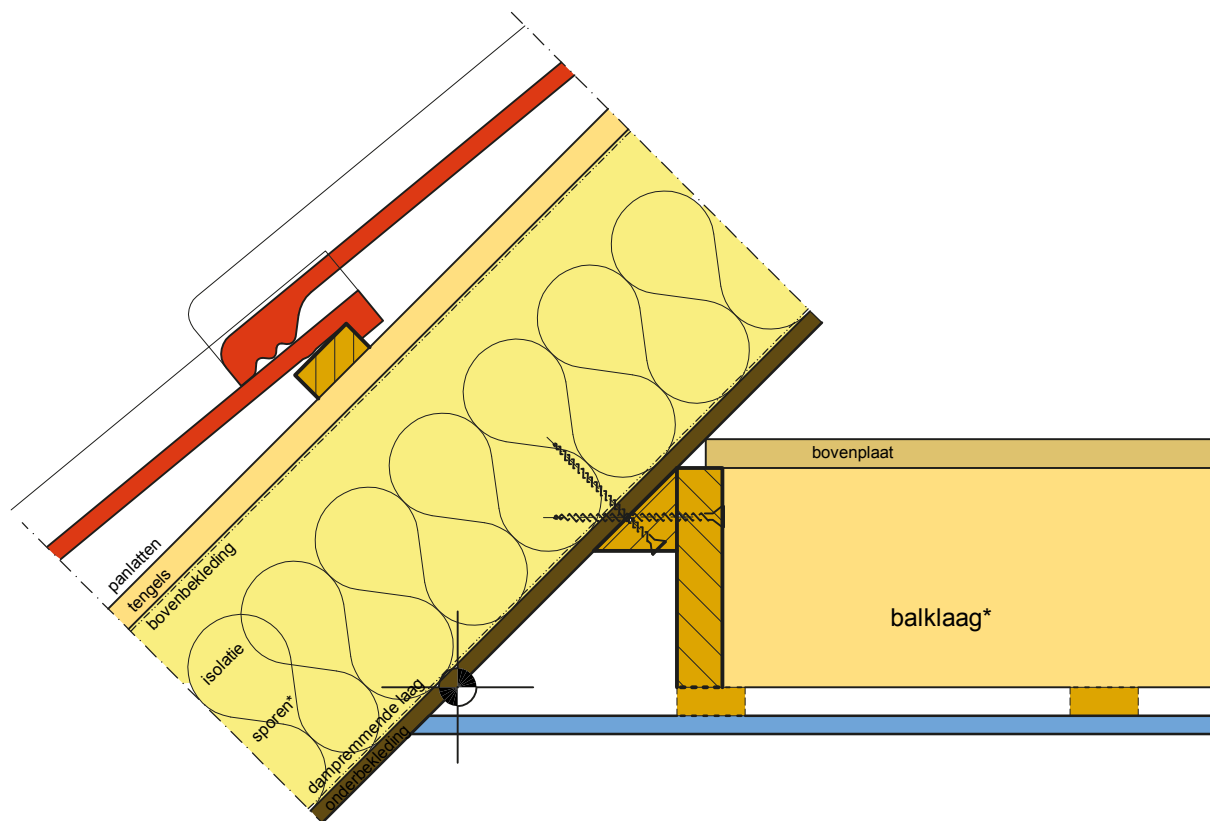

Detail 28: aansluiting vloer/dakconstructie (gording)